

covertec

Ochrana se systémem

Systematic Protection

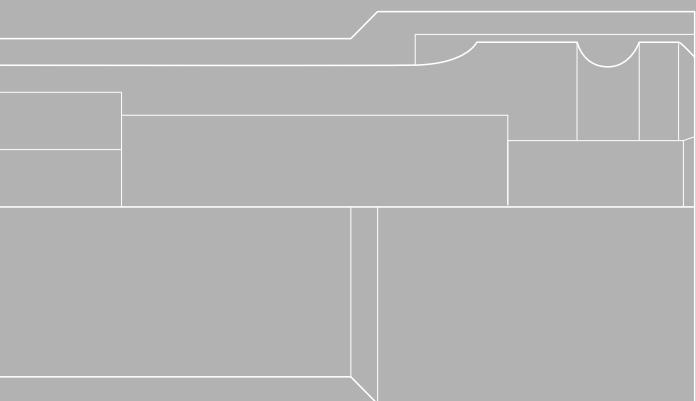

Firma			3
The Company			
System covertec			4
The covertec - System			
Piktogramy covertec			6
covertec-Pictograms			
covertec nářadí			7
covertec tools	Velikost 1/4"	Size 1/4"	7
	Velikost 3/8"	Size 3/8"	15
	Velikost 1/2"	Size 1/2"	31
	Velikost 3/4"	Size 3/4"	49
	Velikost 1"	Size 1"	59
	E6,3	E6,3	65
	E11	E11	81
covertec zacvakávací kryty pro ráčny			83
covertec Click-fit shields			
covertec příslušenství			87
covertec Accessories	Kladivo s měkkou hlavou	Softblow Hammer	88
	Povrchové povlakování	Coating	88
	Přítlačné válečky na lišty	Roller stamp	88
	Boxy na nářadí a rozdělovací vložky	Carrying case and inserts	89
	Tašky na nářadí	Tool bag	90
	Speciální kleště	Special pliers	90
Kontakt			91
Contact			



ekatec GmbH

Optimalizace vašich montážních procesů je centrem naší práce a jsme specialisty na řešení vašich problémů při montáži a šroubování. Všichni známí výrobci automobilů v Evropě se při svých montážních procesech spoléhají na řešení společnosti ekatec GmbH. Na následujících stránkách se můžete přesvědčit o těchto dlouholetých zkušenostech.

The Company

The focus of our activities is the optimization of your assembly processes. We see ourselves as a specialist for the solution of assembly and screwing problems. Numerous considerable car manufacturers are using already our solutions for their assembly processes. On the following pages you can get an impression of these years of experience.

K našemu katalogu

Při montáži vozidla je počet šroubových spojů často až 1000 kusů na vozidlo. Šroubová spojení přímo hraničí s již hotovými lakovanými povrchy i s kovovými a plastovými díly, jejichž povrchy jsou velmi citlivé. Poškození těchto povrchů montážními nástroji je proto na denním pořádku. Téměř každý šroubový spoj proto nese riziko poškození laku a povrchu při montáži.

Není proto divu, že právě tento typ poškození je při montáži stále více uznáván jako nákladový faktor. Týmy pro zajišťování kvality a speciální týmy pro poškození laku, které zkoumají příčiny tohoto poškození, se již používají téměř u všech výrobců a ukazují, jaká pozornost je mezitím věnována tomuto nákladovému faktoru. Optimalizace ekonomické efektivity, neustále se zmenšující instalační prostory a stále obtížnější přístupnost při montáži v důsledku stále složitějších produktů spolu se stále citlivějšími povrchy nevyhnutelně vedou k poškození součástí pomocí standardních nástrojů. Zabránění poškození při montáži stojí proto na prvním místě v seznamu ekonomických faktorů montáže vozidla.

Optimalizace ekonomické účinnosti

Neustále se zmenšující instalační prostory a stále obtížnější přístupnost během montáže v důsledku stále složitějších produktů spolu se stále citlivějšími povrchy nevyhnutelně vedou k poškození součástí pomocí standardních nástrojů. Vyhnutí se poškození při montáži je proto na prvním místě v seznamu ekonomických faktorů montáže vozidla.

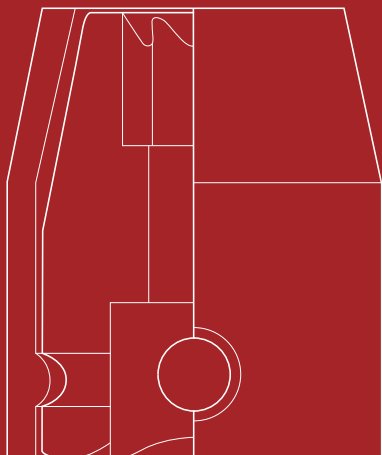

covertec – ochrana se systémem

Covertec – Systematic protection



System covertec

Opravy nutné kvůli poškození při montáži (kontrola, leštění, lakování, výměna,...) na jedné straně vážou zdroje a na druhé straně výrazně zvyšují průměrné doby montáže. Ale zejména v dnešní době s největším nákladovým tlakem a malými maržemi je optimální ziskovost důležitým předpokladem přežití na trhu.

Zlepšení bezpečnosti

Zraněním a nehodám způsobeným rotujícími nástroji, jako je srolování rukavic nebo oblečení je možné se vyhnout. Výsledná zranění jsou značná a dá se jim spolehlivě zabránit použitím našich nástrojů covertec a zejména verzí v provedení Pinch-Point.

Comments on the Catalog

During vehicle assembly, the number of fastening operations often is up to 1000 pieces per vehicle. The screwed directly adjoin already painted surfaces as well as metal and plastic parts whose surfaces are very sensitive. Violations of these surfaces by assembly tools are therefore on the agenda. Nearly every tightening case runs the risk of coatings and surface damage during assembly. Therefore it is not surprising that precisely these damages are recognized increasingly as a cost factor in.

Quality assurance and special Scratch teams who carry out the causes of this damage, are already in use in almost all manufacturers and gives an indication as to which attention is paid to this cost factor in the meantime.

Optimize profitability

Constantly decreasing installation spaces and increasingly difficult accessibilities during assembly due to increasingly complex products with ever more sensitive surfaces lead to damage components with standard tools. To avoid this damages is high on the list of economic efficiency factors of a vehicle assembly.

Improve safety – avoid injury

Accidents caused by rotating tools such as wrap of gloves or clothing are avoidable. The resulting injuries are to be avoided reliably and significantly with the use of our Covertec tools and especially by using the Pinch-point versions.

První nástroje covertec byly zákazníkům dodány společností ekatec GmbH v roce 2005. Mezitím je systém covertec k dispozici pro všechny montážní nástroje. Cílem při vývoji covertec bylo nabídnout kompletní systém, který zabrání poškození laku během procesu montáže, a nikoli pouze izolovaná jednotlivá řešení. Speciální vlastnosti nástrojů covertec jsou dosaženy díky speciálním pouzdrům covertec, které vzešly z mnoha sérií testů.

Rozhodující je ochranná funkce pouzder v kombinaci s velmi dobrou životností ochranných pouzder covertec i základního nástroje. Pouzdra covertec jsou mechanicky oddělena od základního nástroje. Pouzdro zůstane na svém místě i v případě kolize s výrobkem nebo rukavicí. Poškození součásti resp. zranění je tak vyloučeno. Pouzdro je na nástroji covertec pevně namontováno a ani v případě velkého zatížení se ze základního nástroje neuvolní. Pouzdro covertec lze doobjednat samostatně jako náhradní díl pro každý nástroj covertec za nízkou cenu. Pouzdro lze bez problémů sestavit na místě.

The Covertec-System

The first Covertec tools were delivered to customers by the ekatec GmbH in the year of 2005. In the meantime there is the Covertec-system for all assembly tools. Objective in the development of Covertec was to provide a complete system to prevent damages during the assembly process, and not just isolated individual tool solutions.

The special properties of Covertec tools are achieved by the special Covertec sleeves that has emerged from many trials. The decisive factor is the protective function of the sleeves in combination with a very good life of the protective sleeves and also the basic tool.

The Covertec sleeve is mechanically decoupled from the basic tool. In case of a collision, the sleeve will stop. Damages to the component or injury is therefore ruled out. The sleeve is still interlocking mounted on the Covertec tool and does not dissolve even under heavy load from the basic tool.

The sleeve can be ordered as a spare part for each Covertec tool separately. The assembly of the sleeve is easily possible on site.

Piktogramy covertec

Covertec-Pictogramms

6-ti hran
Hexagon profile



Tyčový magnet
Central magnet



Do nástrčné hlavice je zabudován tyčový magnet se značnou magnetickou silou.

Central magnet with strong power.

6-ti hran se 3 magnety / 3PM
6-point socket with 3-point magnet / 3PM



V šestřanu jsou radiálně nainstalovány 3 magnety, které bezpečně drží matici

In the hexagon there are 3 lateral magnets especially for fixing nuts.

Dvojitý 6-ti hran / d6k
Double hexagon



Torx
Torx



Surface-drive Profil / SSD-Profil
Surface-drive Profile / ssd-profile



Pinch-point / PP
Pinch-point / PP



Ochranná manžeta covertec přesahuje na straně pohonu, aby spolehlivě zakryla mezeru, která obvykle vzniká mezi prodloužením a ořechem. Pinch-point lze rozpoznat podle červeného okraje. Poznámka: Všechny nástrčné hlavice covertec jsou k dispozici také ve verzi Pinch-Point (na vyžádání).

The housings are extended to the input side to protect the gap between the socket and the extension. Recognizable by the red border. Note: Pinch-point are available for all covertec sockets (on demand).

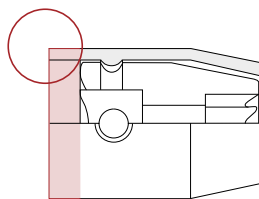

Případ pro Torx + Pinch-point
Example Torx + Pinch-point



Tenkostěnný
Thin wall



Nástrčná hlavice se zmenšeným průměrem pro špatně přístupná místa. Nářadí je schváleno pro strojní provoz.

Sockets with reduced outside diameter but authorized for machine operation.



covertec nářadí

covertec tools

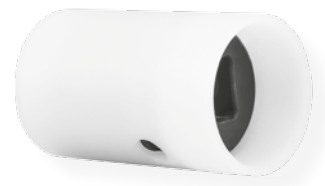
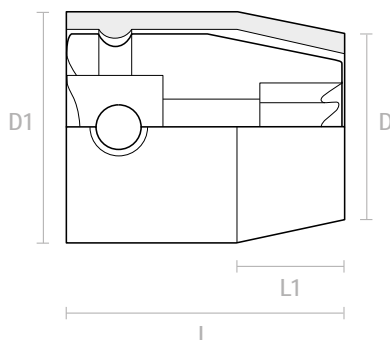

Pinch-point

Nástrčná hlavice 6-ti hranná L23 6-point socket L23



Kód	Pohon	Výstup	L	L1	D1	D	Náhr. pouzdra
Code	Input	Output	L	L1	D1	D	Repl. Sleeves
9041254	1/4"	SW5	23	9	16	12,8	9051254
9041255	1/4"	SW6	23	9	16	13,8	9051255
9041250	1/4"	SW7	23	9	16	14,5	9051250
9041001	1/4"	SW8	23	23	16	16	9051001
9041060	1/4"	SW9	23	23	17	17	9051060
9041002	1/4"	SW10	23	23	18	18	9051002
9041061	1/4"	SW11	23	14	16	19,5	9051061
9041062	1/4"	SW12	23	14	16	20,5	9051062
9041003	1/4"	SW13	23	14,5	18	22	9051003

Nástrčná hlavice 6-ti hranná L23, Pinch-point 6-point socket L23, Pinch-point



Kód	Pohon	Výstup	L	L1	D1	D	Náhr. pouzdra
Code	Input	Output	L	L1	D1	D	Repl. Sleeves
9041254-pp	1/4"	SW5	23	9	16	12,8	9051254-pp
9041255-pp	1/4"	SW6	23	9	16	13,8	9051255-pp
9041250-pp	1/4"	SW7	23	9	16	14,5	9051250-pp
9041001-pp	1/4"	SW8	23	23	16	16	9051001-pp
9041060-pp	1/4"	SW9	23	23	17	17	9051060-pp
9041002-pp	1/4"	SW10	23	23	18	18	9051002-pp
9041061-pp	1/4"	SW11	23	14	16	19,5	9051061-pp
9041062-pp	1/4"	SW12	23	14	16	20,5	9051062-pp
9041003-pp	1/4"	SW13	23	14,5	18	22	9051003-pp

Nástrčná hlavice L23, Torx Socket L23, Torx



Kód	Pohon	Výstup	L	L1	D1	D	Náhr. pouzdra
Code	Input	Output	L	L1	D1	D	Repl. Sleeves
9041183	1/4"	E5	23	9	12	16	9051183
9041184	1/4"	E6	23	9	12	16	9051184
9041185	1/4"	E7	23	9	13	16	9051185
9041004	1/4"	E8	23	9	13	16	9051004
9041005	1/4"	E10	23	23	16	16	9051005
9041251	1/4"	E12	23	23	17	17	9051251

Nástrčná hlavice L23, Torx, Pinch-point Socket L23, Torx, Pinch-point



Kód	Pohon	Výstup	L	L1	D1	D	Náhr. pouzdra
Code	Input	Output	L	L1	D1	D	Repl. Sleeves
9041183-pp	1/4"	E5	23	9	12	16	9051183-pp
9041184-pp	1/4"	E6	23	9	12	16	9051184-pp
9041185-pp	1/4"	E7	23	9	13	16	9051185-pp
9041004-pp	1/4"	E8	23	9	13	16	9051004-pp
9041005-pp	1/4"	E10	23	23	16	16	9051005-pp
9041251-pp	1/4"	E12	23	23	17	17	9051251-pp

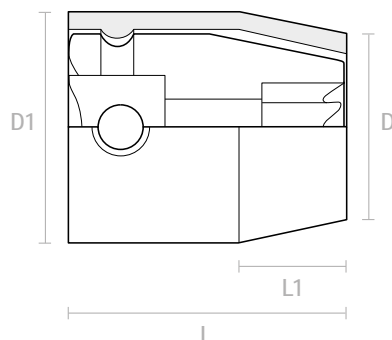

Pinch-point

Nástrčná hlavice 6-ti hranná s tyčovým magnetem L23
6-point socket with central magnet L23



Kód	Pohon	Výstup	L	L1	D1	D	Náhr. pouzdra
Code	Input	Output	L	L1	D1	D	Repl. Sleeves
9041254-1	1/4"	SW5	23	9	16	12,8	9051254-1
9041255-1	1/4"	SW6	23	9	16	13,8	9051255-1
9041250-1	1/4"	SW7	23	9	16	14,5	9051250-1
9041001-1	1/4"	SW8	23	23	16	16	9051001-1
9041060-1	1/4"	SW9	23	23	17	17	9041060-1
9041002-1	1/4"	SW10	23	23	18	18	9051002-1
9041061-1	1/4"	SW11	23	14	16	19,5	9051061-1
9041062-1	1/4"	SW12	23	14	16	20,5	9051062-1
9041003-1	1/4"	SW13	23	14,5	18	22	9051003-1

Nástrčná hlavice 6-ti hranná s tyčovým magnetem L23 , Pinch-p.
6-point socket with central magnet L23, Pinch-point



Kód	Pohon	Výstup	L	L1	D1	D	Náhr. pouzdra
Code	Input	Output	L	L1	D1	D	Repl. Sleeves
9041254-1-pp	1/4"	SW5	23	9	16	12,8	9051254-1-pp
9041255-1-pp	1/4"	SW6	23	9	16	13,8	9051255-1-pp
9041250-1-pp	1/4"	SW7	23	9	16	14,5	9051250-1-pp
9041001-1-pp	1/4"	SW8	23	23	16	16	9051001-1-pp
9041060-1-pp	1/4"	SW9	23	23	17	17	9041060-1-pp
9041002-1-pp	1/4"	SW10	23	23	18	18	9051002-1-pp
9041061-1-pp	1/4"	SW11	23	14	16	19,5	9051061-1-pp
9041062-1-pp	1/4"	SW12	23	14	16	20,5	9051062-1-pp
9041003-1-pp	1/4"	SW13	23	14,5	18	22	9051003-1-pp

Nástrčná hlavice s tyčovým magnetem L23, Torx
Socket with central magnet L23, Torx



Kód	Pohon	Výstup	L	L1	D1	D	Náhr. pouzdra
Code	Input	Output	L	L1	D1	D	Repl. Sleeves
9041183-1	1/4"	E5	23	9	12	16	9051183-1
9041184-1	1/4"	E6	23	9	12	16	9051184-1
9041185-1	1/4"	E7	23	9	13	16	9051185-1
9041004-1	1/4"	E8	23	9	13	16	9051004-1
9041005-1	1/4"	E10	23	23	16	16	9051005-1
9041251-1	1/4"	E12	23	23	17	17	9051251-1

Nástrčná hlavice s tyčovým magnetem L23, Pinch-point, Torx
Socket with central magnet L23, Pinch-point, Torx



Kód	Pohon	Výstup	L	L1	D1	D	Náhr. pouzdra
Code	Input	Output	L	L1	D1	D	Repl. Sleeves
9041183-1-pp	1/4"	E5	23	9	12	16	9051183-1-pp
9041184-1-pp	1/4"	E6	23	9	12	16	9051184-1-pp
9041185-1-pp	1/4"	E7	23	9	13	16	9051185-1-pp
9041004-1-pp	1/4"	E8	23	9	13	16	9051004-1-pp
9041005-1-pp	1/4"	E10	23	23	16	16	9051005-1-pp
9041251-1-pp	1/4"	E12	23	23	17	17	9051251-1-pp

covertec náradí

covertec tools



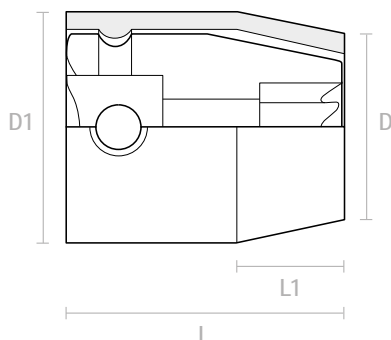

Pinch-point

Nástrčná hlavice 6-ti hranná, 3 bodový magnet L23
6-point socket 3-point magnet L23



Kód	Pohon	Výstup	L	L1	D1	D	Náhr. pouzdra
Code	Input	Output	L	L1	D1	D	Repl. Sleeves
9041254-2	1/4"	SW5	23	9	16	12,8	9051254-2
9041255-2	1/4"	SW6	23	9	16	13,8	9051255-2
9041250-2	1/4"	SW7	23	9	16	14,5	9051250-2
9041001-2	1/4"	SW8	23	23	16	16	9051001-2
9041060-2	1/4"	SW9	23	23	17	17	9051060-2
9041002-2	1/4"	SW10	23	23	18	18	9051002-2
9041061-2	1/4"	SW11	23	14	16	19,5	9051061-2
9041062-2	1/4"	SW12	23	14	16	20,5	9051062-2
9041003-2	1/4"	SW13	23	14,5	18	22	9051003-2

Nástrčná hlavice dvojitý 6-ti hran L23
12-point socket L23



Kód	Pohon	Výstup	L	L1	D1	D	Náhr. pouzdra
Code	Input	Output	L	L1	D1	D	Repl. Sleeves
9041254-5	1/4"	SW5	23	9	16	12,8	9051254-5
9041255-5	1/4"	SW6	23	9	16	13,8	9051255-5
9041250-5	1/4"	SW7	23	9	16	14,5	9051250-5
9041001-5	1/4"	SW8	23	23	16	16	9051001-5
9041060-5	1/4"	SW9	23	23	17	17	9051060-5
9041002-5	1/4"	SW10	23	23	18	18	9051002-5
9041061-5	1/4"	SW11	23	14	16	19,5	9051061-5
9041062-5	1/4"	SW12	23	14	16	20,5	9051062-5
9041003-5	1/4"	SW13	23	14,5	18	22	9051003-5

Nástrčná hlavice 6-ti hranná, 3 bodový magnet L23, Pinch-Point
6-point socket 3-point magnet L23, Pinch-point



Kód	Pohon	Výstup	L	L1	D1	D	Náhr. pouzdra
Code	Input	Output	L	L1	D1	D	Repl. Sleeves
9041254-2-pp	1/4"	SW5	23	9	16	12,8	9051254-2-pp
9041255-2-pp	1/4"	SW6	23	9	16	13,8	9051255-2-pp
9041250-2-pp	1/4"	SW7	23	9	16	14,5	9051250-2-pp
9041001-2-pp	1/4"	SW8	23	23	16	16	9051001-2-pp
9041060-2-pp	1/4"	SW9	23	23	17	17	9051060-2-pp
9041002-2-pp	1/4"	SW10	23	23	18	18	9051002-2-pp
9041061-2-pp	1/4"	SW11	23	14	16	19,5	9051061-2-pp
9041062-2-pp	1/4"	SW12	23	14	16	20,5	9051062-2-pp
9041003-2-pp	1/4"	SW13	23	14,5	18	22	9051003-2-pp

Nástrčná hlavice dvojitý 6-ti hran L23, Pinch-point
12-point socket L23, Pinch-point



Kód	Pohon	Výstup	L	L1	D1	D	Náhr. pouzdra
Code	Input	Output	L	L1	D1	D	Repl. Sleeves
9041254-5-pp	1/4"	SW5	23	9	16	12,8	9051254-5-pp
9041255-5-pp	1/4"	SW6	23	9	16	13,8	9051255-5-pp
9041250-5-pp	1/4"	SW7	23	9	16	14,5	9051250-5-pp
9041001-5-pp	1/4"	SW8	23	23	16	16	9051001-5-pp
9041060-5-pp	1/4"	SW9	23	23	17	17	9051060-5-pp
9041002-5-pp	1/4"	SW10	23	23	18	18	9051002-5-pp
9041061-5-pp	1/4"	SW11	23	14	16	19,5	9051061-5-pp
9041062-5-pp	1/4"	SW12	23	14	16	20,5	9051062-5-pp
9041003-5-pp	1/4"	SW13	23	14,5	18	22	9051003-5-pp

covertec nářadí

covertec tools

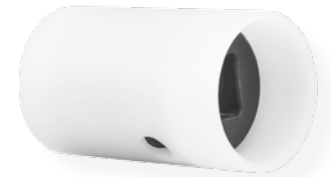
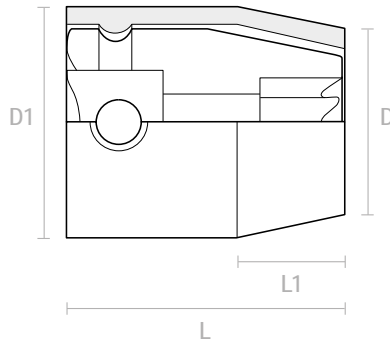

Pinch-point

Nástrčná hlavice Surface-drive L23

Socket surface drive L23



Kód	Pohon	Výstup	L	L1	D1	D	Náhr. pouzdra
Code	In-/	Output	L	L1	D1	D	Repl. Sleeves
9041001-4	1/4"	SW8sd	23	23	16	16	9051001-4
9041060-4	1/4"	SW9sd	23	23	17	17	9051060-4
9041002-4	1/4"	SW10sd	23	23	18	18	9051002-4
9041061-4	1/4"	SW11sd	23	14	16	19,5	9051061-4
9041062-4	1/4"	SW12sd	23	14	16	20,5	9051062-4
9041003-4	1/4"	SW13sd	23	14,5	18	22	9051003-4

Nástrčná hlavice Surface-drive L23, Pinch-point

Socket surface-drive L23, Pinch-point



Kód	Pohon	Výstup	L	L1	D1	D	Náhr. pouzdra
Code	In-/	Output	L	L1	D1	D	Repl. Sleeves
9041001-4-pp	1/4"	SW8sd	23	23	16	16	9051001-4-pp
9041060-4-pp	1/4"	SW9sd	23	23	17	17	9051060-4-pp
9041002-4-pp	1/4"	SW10sd	23	23	18	18	9051002-4-pp
9041061-4-pp	1/4"	SW11sd	23	14	16	19,5	9051061-4-pp
9041062-4-pp	1/4"	SW12sd	23	14	16	20,5	9051062-4-pp
9041003-4-pp	1/4"	SW13sd	23	14,5	18	22	9051003-4-pp

Nástrčná hlavice 6-ti hranná tenkostěnná

6-point socket thin walled



Kód	Pohon	Výstup	L	L1	D1	D	Náhr. pouzdra
Code	In-/	Output	L	L1	D1	D	Repl. Sleeves
9041006-22-10	1/4"	SW6	22	8	14	12	9051006-22-10
9041007-22-10	1/4"	SW7	22	9	14	13	9051007-22-10
9041008-22-10	1/4"	SW8	22	9	14,5	14	9051008-22-10
9041010-22-10	1/4"	SW10	22	22	17	17	9051010-22-10
9041012-22-10	1/4"	SW12	22	22	20	20	9051012-22-10
9041013-22-10	1/4"	SW13	22	22	20,5	20,5	9051013-22-10
9041007-50-10	1/4"	SW7	50	25	14	13	9051007-50-10
9041008-50-10	1/4"	SW8	50	35	14,5	14	9051008-50-10
9041010-50-10	1/4"	SW10	50	50	17	17	9051010-50-10
9041012-50-10	1/4"	SW12	50	50	20	20	9051012-50-10
9041013-50-10	1/4"	SW13	50	50	20,5	20,5	9051013-50-10

Nástrčná hlavice tenkostěnná, Torx

Socket thin walled, Torx



Kód	Pohon	Výstup	L	L1	D1	D	Náhr. pouzdra
Code	In-/	Output	L	L1	D1	D	Repl. Sleeves
90410E06-22-10	1/4"	E6	22	7	14	10,5	90510E06-22-10
90410E07-22-10	1/4"	E7	22	8	14	11	90510E07-22-10
90410E08-22-10	1/4"	E8	22	8	14	12	90510E08-22-10
90410E10-22-10	1/4"	E10	22	9	15	14	90510E10-22-10



Nástrčná hlavice 6-ti hranná tenkostěnná, Pinch-point
6-point socket thin walled, Pinch-point



Kód	Pohon	Výstup	L	L1	D1	D	Náhradní pouzdra
Code	In-/	Output	L	L1	D1	D	Repl. Sleeves
9041006-22-10-pp	1/4"	SW6	22	8	14	12	9051006-22-10-pp
9041007-22-10-pp	1/4"	SW7	22	9	14	13	9051007-22-10-pp
9041008-22-10-pp	1/4"	SW8	22	9	14,5	14	9051008-22-10-pp
9041010-22-10-pp	1/4"	SW10	22	22	17	17	9051010-22-10-pp
9041012-22-10-pp	1/4"	SW12	22	22	20	20	9051012-22-10-pp
9041013-22-10-pp	1/4"	SW13	22	22	20,5	20,5	9051013-22-10-pp
9041007-50-10-pp	1/4"	SW7	50	25	14	13	9051007-50-10-pp
9041008-50-10-pp	1/4"	SW8	50	35	14,5	14	9051008-50-10-pp
9041010-50-10-pp	1/4"	SW10	50	50	17	17	9051010-50-10-pp
9041012-50-10-pp	1/4"	SW12	50	50	20	20	9051012-50-10-pp
9041013-50-10-pp	1/4"	SW13	50	50	20,5	20,5	9051013-50-10-pp

Nástrčná hlavice tenkostěnná, Pinch-point, Torx
Socket thin walled, Pinch-point, Torx



Kód	Pohon	Výstup	L	L1	D1	D	Náhradní pouzdra
Code	In-/	Output	L	L1	D1	D	Repl. Sleeves
90410E06-22-10-pp	1/4"	E6	22	7	14	10,5	90510E06-22-10-pp
90410E07-22-10-pp	1/4"	E7	22	8	14	11	90510E07-22-10-pp
90410E08-22-10-pp	1/4"	E8	22	8	14	12	90510E08-22-10-pp
90410E10-22-10-pp	1/4"	E10	22	9	15	14	90510E10-22-10-pp

covertec nářadí

covertec tools



Prodloužení 1/4"

Extension 1/4"

Kód	Pohon	Výstup	L	L1	D1	D	Náhr. pouzdra
Code	Input	Output	L	L1	D1	D	Repl. Sleeves
9060001	1/4"	1/4"	55	15	16,5	11,5	9061001
9060002	1/4"	1/4"	75	15	16,5	11,5	9061002
9060070	1/4"	1/4"	90	15	16,5	11,5	9061070
9060003	1/4"	1/4"	200	15	16,5	11,5	9061003
9060079	1/4"	1/4"	250	15	16,5	11,5	9061079
7030029	1/4"	1/4"	125	15	16,5	11,5	7030029-2

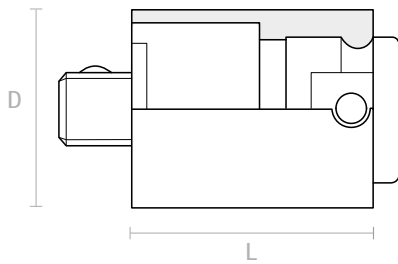

Rychlovýměnné sklíčidlo

Quick-release

Kód	Pohon	Výstup	D	L
Code	Input	Output	D	L
9092001	1/4"	E6,3	20	40

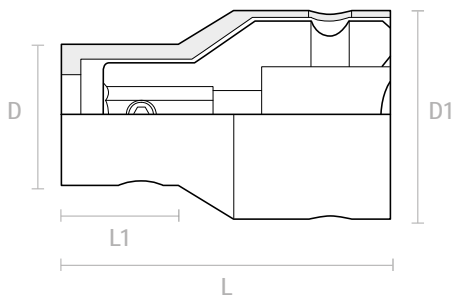

Držák bitů

Bit holder

Kód	Pohon	Výstup	L	L1	D1	D	Bit
Code	Input	Output	L	L1	D1	D	Bit
9091010	1/4"	C6,3	30,5	30,5	17	17	C6,3/ E6,3



covertec 3/8"

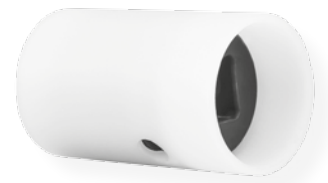
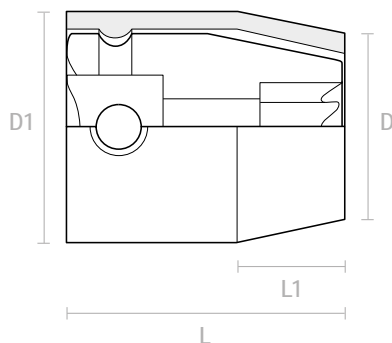

Pinch-point

Nástrčná hlavice 6-ti hranná L32 6-point socket L32



Kód	Pohon	Výstup	L	L1	D1	D	Náhr. pouzdra
Code	Input	Output	L	L1	D1	D	Repl. Sleeves
9041253	3/8"	SW7	32	13	22	16	9051253
9041063	3/8"	SW8	32	11	22	16,5	9051063
9041064	3/8"	SW9	32	11	22	18	9051064
9041006	3/8"	SW10	32	14	22	19	9051006
9041048	3/8"	SW11	32	16,5	22	20	9051048
9041049	3/8"	SW12	32	32	22	22	9051049
9041007	3/8"	SW13	32	32	25	25	9051007
9041008	3/8"	SW14	32	32	25	25	9051008
9041009	3/8"	SW15	32	32	25	25	9051009
9041010	3/8"	SW16	32	32	27	27	9051010
9041011	3/8"	SW17	32	32	28	28	9051011
9041012	3/8"	SW18	32	32	29,5	29,5	9051012
9041013	3/8"	SW19	32	32	30,5	30,5	9051013

Nástrčná hlavice 6-ti hranná L32, Pinch-point 6-point socket L32, Pinch-point



Kód	Pohon	Výstup	L	L1	D1	D	Náhr. pouzdra
Code	Input	Output	L	L1	D1	D	Repl. Sleeves
9041253-pp	3/8"	SW7	32	13	22	16	9051253-pp
9041063-pp	3/8"	SW8	32	11	22	16,5	9051063-pp
9041064-pp	3/8"	SW9	32	11	22	18	9051064-pp
9041006-pp	3/8"	SW10	32	14	22	19	9051006-pp
9041048-pp	3/8"	SW11	32	16,5	22	20	9051048-pp
9041049-pp	3/8"	SW12	32	32	22	22	9051049-pp
9041007-pp	3/8"	SW13	32	32	25	25	9051007-pp
9041008-pp	3/8"	SW14	32	32	25	25	9051008-pp
9041009-pp	3/8"	SW15	32	32	25	25	9051009-pp
9041010-pp	3/8"	SW16	32	32	27	27	9051010-pp
9041011-pp	3/8"	SW17	32	32	28	28	9051011-pp
9041012-pp	3/8"	SW18	32	32	29,5	29,5	9051012-pp
9041013-pp	3/8"	SW19	32	32	30,5	30,5	9051013-pp

Nástrčná hlavice L32, Torx Socket L32, Torx



Kód	Pohon	Výstup	L	L1	D1	D	Náhr. pouzdra
Code	Input	Output	L	L1	D1	D	Repl. Sleeves
9041186	3/8"	E5	32	17	22	14	9051186
9041187	3/8"	E6	32	17	22	15	9051187
9041188	3/8"	E7	32	17	22	15	9051188
9041014	3/8"	E8	32	14	22	16,5	9051014
9041015	3/8"	E10	32	14	22	16,5	9051015
9041016	3/8"	E12	32	14	22	18,5	9051016
9041017	3/8"	E14	32	32	22	22	9051017
9041189	3/8"	E16	32	32	23	23	9051189
9041018	3/8"	E18	32	32	25,5	25,5	9051018

Nástrčná hlavice L32, Pinch-point, Torx Socket L32, Pinch-point, Torx



Kód	Pohon	Výstup	L	L1	D1	D	Náhr. pouzdra
Code	Input	Output	L	L1	D1	D	Repl. Sleeves
9041186-pp	3/8"	E5	32	17	22	14	9051186-pp
9041187-pp	3/8"	E6	32	17	22	15	9051187-pp
9041188-pp	3/8"	E7	32	17	22	15	9051188-pp
9041014-pp	3/8"	E8	32	14	22	16,5	9051014-pp
9041015-pp	3/8"	E10	32	14	22	16,5	9051015-pp
9041016-pp	3/8"	E12	32	14	22	18,5	9051016-pp
9041017-pp	3/8"	E14	32	32	22	22	9051017-pp
9041189-pp	3/8"	E16	32	32	23	23	9051189-pp
9041018-pp	3/8"	E18	32	32	25,5	25,5	9051018-pp

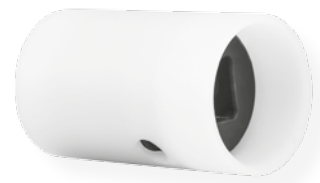
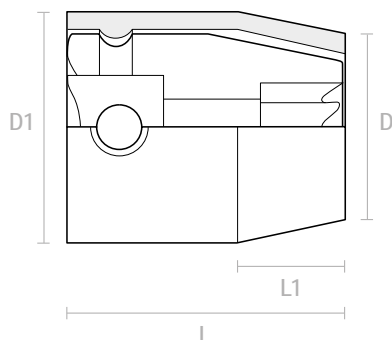

Pinch-point

Nástrčná hlavice 6-ti hranná s tyčovým magnetem L23
6-point socket with central magnet L32



Kód	Pohon	Výstup	L	L1	D1	D	Náhr. pouzdra
Code	Input	Output	L	L1	D1	D	Repl. Sleeves
9041063-1	3/8"	SW8	32	11	22	16,5	9051063-1
9041064-1	3/8"	SW9	32	11	22	18	9051064-1
9041006-1	3/8"	SW10	32	14	22	19	9051006-1
9041048-1	3/8"	SW11	32	16,5	22	20	9051048-1
9041049-1	3/8"	SW12	32	32	22	22	9051049-1
9041007-1	3/8"	SW13	32	32	25	25	9051007-1
9041008-1	3/8"	SW14	32	32	25	25	9051008-1
9041009-1	3/8"	SW15	32	32	25	25	9051009-1
9041010-1	3/8"	SW16	32	32	27	27	9051010-1
9041011-1	3/8"	SW17	32	32	28	28	9051011-1
9041012-1	3/8"	SW18	32	32	29,5	29,5	9051012-1
9041013-1	3/8"	SW19	32	32	30,5	30,5	9051013-1

Nástrčná hlavice 6-ti hranná s tyčovým magnetem L32, Pinch-p.
6-point socket with central magnet L32, Pinch-point



Kód	Pohon	Výstup	L	L1	D1	D	Náhr. pouzdra
Code	Input	Output	L	L1	D1	D	Repl. Sleeves
9041063-1-pp	3/8"	SW8	32	11	22	16,5	9051063-1-pp
9041064-1-pp	3/8"	SW9	32	11	22	18	9051064-1-pp
9041006-1-pp	3/8"	SW10	32	14	22	19	9051006-1-pp
9041048-1-pp	3/8"	SW11	32	16,5	22	20	9051048-1-pp
9041049-1-pp	3/8"	SW12	32	32	22	22	9051049-1-pp
9041007-1-pp	3/8"	SW13	32	32	25	25	9051007-1-pp
9041008-1-pp	3/8"	SW14	32	32	25	25	9051008-1-pp
9041009-1-pp	3/8"	SW15	32	32	25	25	9051009-1-pp
9041010-1-pp	3/8"	SW16	32	32	27	27	9051010-1-pp
9041011-1-pp	3/8"	SW17	32	32	28	28	9051011-1-pp
9041012-1-pp	3/8"	SW18	32	32	29,5	29,5	9051012-1-pp
9041013-1-pp	3/8"	SW19	32	32	30,5	30,5	9051013-1-pp

Nástrčná hlavice s tyčovým magnetem L32, Torx
Socket with central magnet L32, Torx



Kód	Pohon	Výstup	L	L1	D1	D	Náhr. pouzdra
Code	Input	Output	L	L1	D1	D	Repl. Sleeves
9041186-1	3/8"	E5	32	17	22	14	9051186-1
9041187-1	3/8"	E6	32	17	22	15	9051187-1
9041188-1	3/8"	E7	32	17	22	15	9051188-1
9041014-1	3/8"	E8	32	14	22	16,5	9051014-1
9041015-1	3/8"	E10	32	14	22	16,5	9051015-1
9041016-1	3/8"	E12	32	14	22	18,5	9051016-1
9041017-1	3/8"	E14	32	32	22	22	9051017-1
9041189-1	3/8"	E16	32	32	23	23	9051189-1
9041018-1	3/8"	E18	32	32	25,5	25,5	9051018-1

Nástrčná hlavice s tyčovým magnetem L32, Pinch-point, Torx
Socket with central magnet L32, Pinch-point, Torx



Kód	Pohon	Výstup	L	L1	D1	D	Náhr. pouzdra
Code	Input	Output	L	L1	D1	D	Repl. Sleeves
9041186-1-pp	3/8"	E5	32	17	22	14	9041186-1-pp
9041187-1-pp	3/8"	E6	32	17	22	15	9041187-1-pp
9041188-1-pp	3/8"	E7	32	17	22	15	9041188-1-pp
9041014-1-pp	3/8"	E8	32	14	22	16,5	9041014-1-pp
9041015-1-pp	3/8"	E10	32	14	22	16,5	9041015-1-pp
9041016-1-pp	3/8"	E12	32	14	22	18,5	9041016-1-pp
9041017-1-pp	3/8"	E14	32	32	22	22	9041017-1-pp
9041189-1-pp	3/8"	E16	32	32	23	23	9041189-1-pp
9041018-1-pp	3/8"	E18	32	32	25,5	25,5	9041018-1-pp

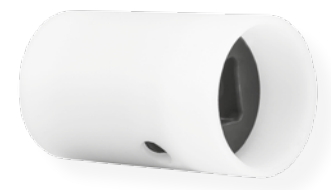
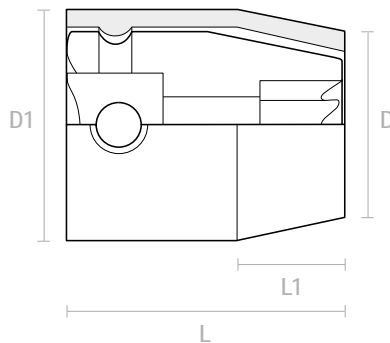

Pinch-point

Nástrčná hlavice 6-ti hranná 3 bodový magnet L32 6-point socket 3-point magnet L32



Kód	Pohon	Výstup	L	L1	D1	D	Náhr. pouzdra
Code	In-/	Output	L	L1	D1	D	Repl. Sleeves
9041063-2	3/8"	SW8	32	11	22	16,5	9051063-2
9041064-2	3/8"	SW9	32	11	22	18	9051064-2
9041006-2	3/8"	SW10	32	14	22	19	9051006-2
9041048-2	3/8"	SW11	32	16,5	22	20	9051048-2
9041049-2	3/8"	SW12	32	32	22	22	9051049-2
9041007-2	3/8"	SW13	32	32	25	25	9051007-2
9041008-2	3/8"	SW14	32	32	25	25	9051008-2
9041009-2	3/8"	SW15	32	32	25	25	9051009-2
9041010-2	3/8"	SW16	32	32	27	27	9051010-2
9041011-2	3/8"	SW17	32	32	28	28	9051011-2
9041012-2	3/8"	SW18	32	32	29,5	29,5	9051012-2
9041013-2	3/8"	SW19	32	32	30,5	30,5	9051013-2

Nástrčná hlavice Surface-drive L32 Socket surface-drive L32



Kód	Pohon	Výstup	L	L1	D1	D	Náhr. pouzdra
Code	In-/	Output	L	L1	D1	D	Repl. Sleeves
9041063-4	3/8"	SW8sd	32	11	22	16,5	9051063-4
9041064-4	3/8"	SW9sd	32	11	22	18	9051064-4
9041006-4	3/8"	SW10sd	32	14	22	19	9051006-4
9041048-4	3/8"	SW11sd	32	16,5	22	20	9051048-4
9041049-4	3/8"	SW12sd	32	32	22	22	9051049-4
9041007-4	3/8"	SW13sd	32	32	25	25	9051007-4
9041008-4	3/8"	SW14sd	32	32	25	25	9051008-4
9041009-4	3/8"	SW15sd	32	32	25	25	9051009-4
9041010-4	3/8"	SW16sd	32	32	27	27	9051010-4
9041011-4	3/8"	SW17sd	32	32	28	28	9051011-4
9041012-4	3/8"	SW18sd	32	32	29,5	29,5	9051012-4
9041013-4	3/8"	SW19sd	32	32	30,5	30,5	9051013-4

Nástrčná hlavice 6-ti hranná 3 bodový magnet L32, Pinch-point 6-point socket 3-point magnet L32, Pinch-point



Kód	Pohon	Výstup	L	L1	D1	D	Náhr. pouzdra
Code	In-/	Output	L	L1	D1	D	Repl. Sleeves
9041063-2-pp	3/8"	SW8	32	11	22	16,5	9051063-2-pp
9041064-2-pp	3/8"	SW9	32	11	22	18	9051064-2-pp
9041006-2-pp	3/8"	SW10	32	14	22	19	9051006-2-pp
9041048-2-pp	3/8"	SW11	32	16,5	22	20	9051048-2-pp
9041049-2-pp	3/8"	SW12	32	32	22	22	9051049-2-pp
9041007-2-pp	3/8"	SW13	32	32	25	25	9051007-2-pp
9041008-2-pp	3/8"	SW14	32	32	25	25	9051008-2-pp
9041009-2-pp	3/8"	SW15	32	32	25	25	9051009-2-pp
9041010-2-pp	3/8"	SW16	32	32	27	27	9051010-2-pp
9041011-2-pp	3/8"	SW17	32	32	28	28	9051011-2-pp
9041012-2-pp	3/8"	SW18	32	32	29,5	29,5	9051012-2-pp
9041013-2-pp	3/8"	SW19	32	32	30,5	30,5	9051013-2-pp

Nástrčná hlavice Surface-drive L32, Pinch-point Socket surface-drive L32, Pinch-point



Kód	Pohon	Výstup	L	L1	D1	D	Náhr. pouzdra
Code	In-/	Output	L	L1	D1	D	Repl. Sleeves
9041063-4-pp	3/8"	SW8sd	32	11	22	16,5	9051063-4-pp
9041064-4-pp	3/8"	SW9sd	32	11	22	18	9051064-4-pp
9041006-4-pp	3/8"	SW10sd	32	14	22	19	9051006-4-pp
9041048-4-pp	3/8"	SW11sd	32	16,5	22	20	9051048-4-pp
9041049-4-pp	3/8"	SW12sd	32	32	22	22	9051049-4-pp
9041007-4-pp	3/8"	SW13sd	32	32	25	25	9051007-4-pp
9041008-4-pp	3/8"	SW14sd	32	32	25	25	9051008-4-pp
9041009-4-pp	3/8"	SW15sd	32	32	25	25	9051009-4-pp
9041010-4-pp	3/8"	SW16sd	32	32	27	27	9051010-4-pp
9041011-4-pp	3/8"	SW17sd	32	32	28	28	9051011-4-pp
9041012-4-pp	3/8"	SW18sd	32	32	29,5	29,5	9051012-4-pp
9041013-4-pp	3/8"	SW19sd	32	32	30,5	30,5	9051013-4-pp

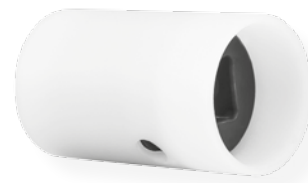
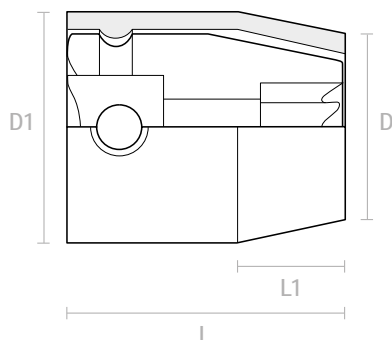

Pinch-point

Nástrčná hlavice dvojitý 6-ti hran L32

12-point socket L32



Kód	Pohon	Výstup	L	L1	D1	D	Náhr. pouzdra
Code	In-/	Output	L	L1	D1	D	Repl. Sleeves
9041063-5	3/8"	SW8	32	11	22	16,5	9051063-5
9041064-5	3/8"	SW9	32	11	22	18	9051064-5
9041006-5	3/8"	SW10	32	14	22	19	9051006-5
9041048-5	3/8"	SW11	32	16,5	22	20	9051048-5
9041049-5	3/8"	SW12	32	32	22	22	9051049-5
9041007-5	3/8"	SW13	32	32	25	25	9051007-5
9041008-5	3/8"	SW14	32	32	25	25	9051008-5
9041009-5	3/8"	SW15	32	32	25	25	9051009-5
9041010-5	3/8"	SW16	32	32	27	27	9051010-5
9041011-5	3/8"	SW17	32	32	28	28	9051011-5
9041012-5	3/8"	SW18	32	32	29,5	29,5	9051012-5
9041013-5	3/8"	SW19	32	32	30,5	30,5	9051013-5

Nástrčná hlavice 6-ti hraná tenkostěnná

6-point socket thin walled



Kód	Pohon	Výstup	L	L1	D1	D	Náhr. pouzdra
Code	In-/	Output	L	L1	D1	D	Repl. Sleeves
9041106-26-10	3/8"	SW6	26	6	20	13	9051106-26-10
9041107-26-10	3/8"	SW7	26	6,5	20	14	9051107-26-10
9041108-26-10	3/8"	SW8	26	7	20	15	9051108-26-10
9041110-26-10	3/8"	SW10	26	8	20	17	9051110-26-10
9041111-26-10	3/8"	SW11	26	8	20	19	9051111-26-10
9041112-26-10	3/8"	SW12	26	26	20	20	9051112-26-10
9041113-26-10	3/8"	SW13	26	26	20,5	20,5	9051113-26-10
9041114-27-10	3/8"	SW14	27	27	23	23	9051114-27-10
9041115-28-10	3/8"	SW15	28	28	24	24	9051115-28-10
9041116-28-10	3/8"	SW16	28	28	25	25	9051116-28-10
9041117-29-10	3/8"	SW17	29	29	26,5	26,5	9051117-29-10
9041118-30-10	3/8"	SW18	30	30	27,5	27,5	9051118-30-10
9041119-30-10	3/8"	SW19	30	30	28,5	28,5	9051119-30-10
9041121-32-10	3/8"	SW21	32	32	31	31	9051121-32-10

Nástrčná hlavice dvojitý 6-ti hran L32, Pinch-point

12-point socket L32, Pinch-point



Kód	Pohon	Výstup	L	L1	D1	D	Náhr. pouzdra
Code	In-/	Output	L	L1	D1	D	Repl. Sleeves
9041063-5-pp	3/8"	SW8	32	11	22	16,5	9051063-5-pp
9041064-5-pp	3/8"	SW9	32	11	22	18	9051064-5-pp
9041006-5-pp	3/8"	SW10	32	14	22	19	9051006-5-pp
9041048-5-pp	3/8"	SW11	32	16,5	22	20	9051048-5-pp
9041049-5-pp	3/8"	SW12	32	32	22	22	9051049-5-pp
9041007-5-pp	3/8"	SW13	32	32	25	25	9051007-5-pp
9041008-5-pp	3/8"	SW14	32	32	25	25	9051008-5-pp
9041009-5-pp	3/8"	SW15	32	32	25	25	9051009-5-pp
9041010-5-pp	3/8"	SW16	32	32	27	27	9051010-5-pp
9041011-5-pp	3/8"	SW17	32	32	28	28	9051011-5-pp
9041012-5-pp	3/8"	SW18	32	32	29,5	29,5	9051012-5-pp
9041013-5-pp	3/8"	SW19	32	32	30,5	30,5	9051013-5-pp

Nástrčná hlavice 6-ti hraná tenkostěnná, Pinch-point

6-point socket thin walled, Pinch-point



Kód	Pohon	Výstup	L	L1	D1	D	Náhr. pouzdra
Code	In-/	Output	L	L1	D1	D	Repl. Sleeves
9041106-26-10-pp	3/8"	SW6	26	6	20	13	9051106-26-10-pp
9041107-26-10-pp	3/8"	SW7	26	6,5	20	14	9041107-26-10-pp
9041108-26-10-pp	3/8"	SW8	26	7	20	15	9041108-26-10-pp
9041110-26-10-pp	3/8"	SW10	26	8	20	17	9041110-26-10-pp
9041111-26-10-pp	3/8"	SW11	26	8	20	19	9041111-26-10-pp
9041112-26-10-pp	3/8"	SW12	26	26	20	20	9041112-26-10-pp
9041113-26-10-pp	3/8"	SW13	26	26	20,5	20,5	9041113-26-10-pp
9041114-27-10-pp	3/8"	SW14	27	27	23	23	9041114-27-10-pp
9041115-28-10-pp	3/8"	SW15	28	28	24	24	9041115-28-10-pp
9041116-28-10-pp	3/8"	SW16	28	28	25	25	9041116-28-10-pp
9041117-29-10-pp	3/8"	SW17	29	29	26,5	26,5	9041117-29-10-pp
9041118-30-10-pp	3/8"	SW18	30	30	27,5	27,5	9041118-30-10-pp
9041119-30-10-pp	3/8"	SW19	30	30	28,5	28,5	9041119-30-10-pp
9041121-32-10-pp	3/8"	SW21	32	32	31	31	9041121-32-10-pp

covertec nářadí

covertec tools

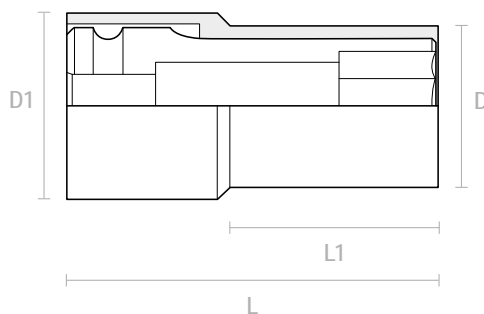

Pinch-point

Nástrčná hlavice 6-ti hranná L50 6-point socket L50



Kód	Pohon	Výstup	L	L1	D1	D	Náhr. pouzdra
Code	Input	Output	L	L1	D1	D	Repl. Sleeves
9041067	3/8"	SW8	50	25	22	16	9051067
9041068	3/8"	SW9	50	30	22	16,5	9051068
9041028	3/8"	SW10	50	26	22	18	9051028
9041069	3/8"	SW11	50	30	22	19,5	9051069
9041070	3/8"	SW12	50	50	22	22	9051070
9041029	3/8"	SW13	50	28	25,5	22	9051029
9041071	3/8"	SW14	50	30	23,2	25	9051071
9041072	3/8"	SW15	50	50	26	26	9051072
9041041	3/8"	SW16	50	50	26	26	9051041
9041073	3/8"	SW17	50	50	26,8	26,8	9041073
9041074	3/8"	SW18	50	35	27	28,5	9051074
9041075	3/8"	SW19	50	35	27	29,5	9051075
9041076	3/8"	SW21	50	35	26	32	9051076
9041077	3/8"	SW22	50	34	26	33,4	9051077
9041078	3/8"	SW24	50	34	26	35	9051078

Nástrčná hlavice 6-ti hranná s tyčovým magnetem L50 6-point socket with central magnet L50



Kód	Pohon	Výstup	L	L1	D1	D	Náhr. pouzdra
Code	Input	Output	L	L1	D1	D	Repl. Sleeves
9041067-1	3/8"	SW8	50	25	22	16	9051067-1
9041068-1	3/8"	SW9	50	30	22	16,5	9051068-1
9041028-1	3/8"	SW10	50	26	22	18	9051028-1
9041069-1	3/8"	SW11	50	30	22	19,5	9051069-1
9041070-1	3/8"	SW12	50	50	22	22	9051070-1
9041029-1	3/8"	SW13	50	28	25,5	22	9051029-1
9041071-1	3/8"	SW14	50	30	23,2	25	9051071-1
9041072-1	3/8"	SW15	50	50	26	26	9051072-1
9041041-1	3/8"	SW16	50	50	26	26	9051041-1
9041073-1	3/8"	SW17	50	50	26,8	26,8	9051073-1
9041074-1	3/8"	SW18	50	35	27	28,5	9051074-1
9041075-1	3/8"	SW19	50	35	27	29,5	9051075-1
9041076-1	3/8"	SW21	50	35	26	32	9051076-1
9041077-1	3/8"	SW22	50	34	26	33,4	9051077-1
9041078-1	3/8"	SW24	50	34	26	35	9051078-1

Nástrčná hlavice 6-ti hranná L50, Pinch-point 6-point socket L50, Pinch-point



Kód	Pohon	Výstup	L	L1	D1	D	Náhr. pouzdra
Code	Input	Output	L	L1	D1	D	Repl. Sleeves
9041067-pp	3/8"	SW8	50	25	22	16	9051067-pp
9041068-pp	3/8"	SW9	50	30	22	16,5	9051068-pp
9041028-pp	3/8"	SW10	50	26	22	18	9051028-pp
9041069-pp	3/8"	SW11	50	30	22	19,5	9051069-pp
9041070-pp	3/8"	SW12	50	50	22	22	9051070-pp
9041029-pp	3/8"	SW13	50	28	25,5	22	9051029-pp
9041071-pp	3/8"	SW14	50	30	23,2	25	9051071-pp
9041072-pp	3/8"	SW15	50	50	26	26	9051072-pp
9041041-pp	3/8"	SW16	50	50	26	26	9051041-pp
9041073-pp	3/8"	SW17	50	50	26,8	26,8	9041073-pp
9041074-pp	3/8"	SW18	50	35	27	28,5	9051074-pp
9041075-pp	3/8"	SW19	50	35	27	29,5	9051075-pp
9041076-pp	3/8"	SW21	50	35	26	32	9051076-pp
9041077-pp	3/8"	SW22	50	34	26	33,4	9051077-pp
9041078-pp	3/8"	SW24	50	34	26	35	9051078-pp

Nástrčná hlavice s tyčovým magnetem L50, Pinch-point Socket with central magnet L50, Pinch-point



Kód	Pohon	Výstup	L	L1	D1	D	Náhr. pouzdra
Code	Input	Output	L	L1	D1	D	Repl. Sleeves
9041067-1-pp	3/8"	SW8	50	25	22	16	9051067-1-pp
9041068-1-pp	3/8"	SW9	50	30	22	16,5	9051068-1-pp
9041028-1-pp	3/8"	SW10	50	26	22	18	9051028-1-pp
9041069-1-pp	3/8"	SW11	50	30	22	19,5	9051069-1-pp
9041070-1-pp	3/8"	SW12	50	50	22	22	9051070-1-pp
9041029-1-pp	3/8"	SW13	50	28	25,5	22	9051029-1-pp
9041071-1-pp	3/8"	SW14	50	30	23,2	25	9051071-1-pp
9041072-1-pp	3/8"	SW15	50	50	26	26	9051072-1-pp
9041041-1-pp	3/8"	SW16	50	50	26	26	9051041-1-pp
9041073-1-pp	3/8"	SW17	50	50	26,8	26,8	9051073-1-pp
9041074-1-pp	3/8"	SW18	50	35	27	28,5	9051074-1-pp
9041075-1-pp	3/8"	SW19	50	35	27	29,5	9051075-1-pp
9041076-1-pp	3/8"	SW21	50	35	26	32	9051076-1-pp
9041077-1-pp	3/8"	SW22	50	34	26	33,4	9051077-1-pp
9041078-1-pp	3/8"	SW24	50	34	26	35	9051078-1-pp

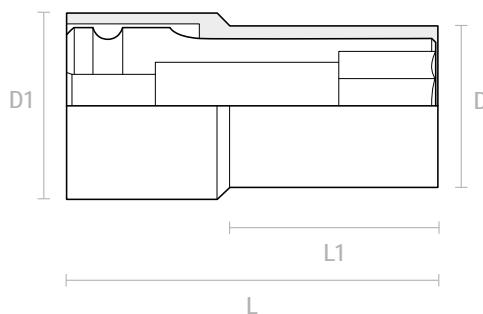

Pinch-point

Nástrčná hlavice 6-ti hranná 3 bodový magnet L50
6-point socket 3-point magnet L50



Kód	Pohon	Výstup	L	L1	D1	D	Náhr. pouzdra
Code	Input	Output	L	L1	D1	D	Repl. Sleeves
9041067-2	3/8"	SW8	50	25	22	16	9051067-2
9041068-2	3/8"	SW9	50	30	22	16,5	9051068-2
9041028-2	3/8"	SW10	50	26	22	18	9051028-2
9041069-2	3/8"	SW11	50	30	22	19,5	9051069-2
9041070-2	3/8"	SW12	50	50	22	22	9051070-2
9041029-2	3/8"	SW13	50	28	25,5	22	9051029-2
9041071-2	3/8"	SW14	50	30	23,2	25	9051071-2
9041072-2	3/8"	SW15	50	50	26	26	9051072-2
9041041-2	3/8"	SW16	50	50	26	26	9051041-2
9041073-2	3/8"	SW17	50	50	26,8	26,8	9051073-2
9041074-2	3/8"	SW18	50	35	27	28,5	9051074-2
9041075-2	3/8"	SW19	50	35	27	29,5	9051075-2
9041076-2	3/8"	SW21	50	35	26	32	9051076-2
9041077-2	3/8"	SW22	50	34	26	33,4	9051077-2
9041078-2	3/8"	SW24	50	34	26	35	9051078-2

Nástrčná hlavice Surface-drive L50
Socket surface-drive L50



Kód	Pohon	Výstup	L	L1	D1	D	Náhr. pouzdra
Code	Input	Output	L	L1	D1	D	Repl. Sleeves
9041067-4	3/8"	SW8sd	50	25	22	16	9051067-4
9041068-4	3/8"	SW9sd	50	30	22	16,5	9051068-4
9041028-4	3/8"	SW10sd	50	26	22	18	9041028-4
9041069-4	3/8"	SW11sd	50	30	22	19,5	9051069-4
9041070-4	3/8"	SW12sd	50	50	22	22	9051070-4
9041029-4	3/8"	SW13sd	50	28	25,5	22	9051029-4
9041071-4	3/8"	SW14sd	50	30	23,2	25	9051071-4
9041072-4	3/8"	SW15sd	50	50	26	26	9051072-4
9041041-4	3/8"	SW16sd	50	50	26	26	9051041-4
9041073-4	3/8"	SW17sd	50	50	26,8	26,8	9051073-4
9041074-4	3/8"	SW18sd	50	35	27	28,5	9051074-4
9041075-4	3/8"	SW19sd	50	35	27	29,5	9051075-4
9041076-4	3/8"	SW21sd	50	35	26	32	9051076-4
9041077-4	3/8"	SW22sd	50	34	26	33,4	9051077-4
9041078-4	3/8"	SW24sd	50	34	26	35	9051078-4

Nástrčná hlavice 6-ti hranná 3 bodový magnet L50, Pinch-point
6-point socket 3-point magnet L50, Pinch-point



Kód	Pohon	Výstup	L	L1	D1	D	Náhr. pouzdra
Code	Input	Output	L	L1	D1	D	Repl. Sleeves
9041067-2-pp	3/8"	SW8	50	25	22	16	9051067-2-pp
9041068-2-pp	3/8"	SW9	50	30	22	16,5	9051068-2-pp
9041028-2-pp	3/8"	SW10	50	26	22	18	9051028-2-pp
9041069-2-pp	3/8"	SW11	50	30	22	19,5	9051069-2-pp
9041070-2-pp	3/8"	SW12	50	50	22	22	9051070-2-pp
9041029-2-pp	3/8"	SW13	50	28	25,5	22	9051029-2-pp
9041071-2-pp	3/8"	SW14	50	30	23,2	25	9051071-2-pp
9041072-2-pp	3/8"	SW15	50	50	26	26	9051072-2-pp
9041041-2-pp	3/8"	SW16	50	50	26	26	9051041-2-pp
9041073-2-pp	3/8"	SW17	50	50	26,8	26,8	9051073-2-pp
9041074-2-pp	3/8"	SW18	50	35	27	28,5	9051074-2-pp
9041075-2-pp	3/8"	SW19	50	35	27	29,5	9051075-2-pp
9041076-2-pp	3/8"	SW21	50	35	26	32	9051076-2-pp
9041077-2-pp	3/8"	SW22	50	34	26	33,4	9051077-2-pp
9041078-2-pp	3/8"	SW24	50	34	26	35	9051078-2-pp

Nástrčná hlavice Surface-drive L50, Pinch-point
Socket surface-drive L50, Pinch-point



Kód	Pohon	Výstup	L	L1	D1	D	Náhr. pouzdra
Code	Input	Output	L	L1	D1	D	Repl. Sleeves
9041067-4	3/8"	SW8sd	50	25	22	16	9051067-4
9041068-4	3/8"	SW9sd	50	30	22	16,5	9051068-4
9041028-4	3/8"	SW10sd	50	26	22	18	9041028-4
9041069-4	3/8"	SW11sd	50	30	22	19,5	9051069-4
9041070-4	3/8"	SW12sd	50	50	22	22	9051070-4
9041029-4	3/8"	SW13sd	50	28	25,5	22	9051029-4
9041071-4	3/8"	SW14sd	50	30	23,2	25	9051071-4
9041072-4	3/8"	SW15sd	50	50	26	26	9051072-4
9041041-4	3/8"	SW16sd	50	50	26	26	9051041-4
9041073-4	3/8"	SW17sd	50	50	26,8	26,8	9051073-4
9041074-4	3/8"	SW18sd	50	35	27	28,5	9051074-4
9041075-4	3/8"	SW19sd	50	35	27	29,5	9051075-4
9041076-4	3/8"	SW21sd	50	35	26	32	9051076-4
9041077-4	3/8"	SW22sd	50	34	26	33,4	9051077-4
9041078-4	3/8"	SW24sd	50	34	26	35	9051078-4

covertec nářadí

covertec tools

covertec 3/8"

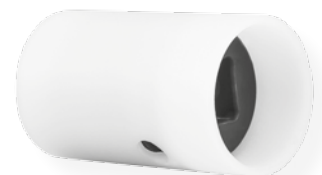
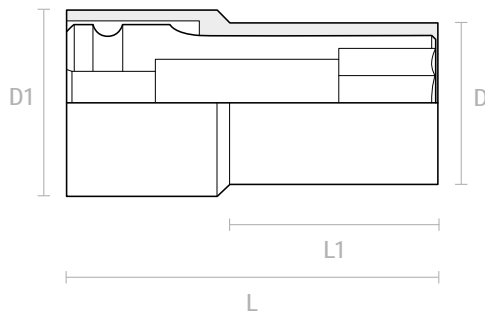

Pinch-point

Nástrčná hlavice dvojitý 6-ti hran L50

12-point socket L50



Kód	Pohon	Výstup	L	L1	D1	D	Náhr. pouzdra
Code	In-/	Output	L	L1	D1	D	Repl. Sleeves
9041067-5	3/8"	SW8	50	25	22	16	9051067-5
9041068-5	3/8"	SW9	50	30	22	16,5	9051068-5
9041028-5	3/8"	SW10	50	26	22	18	9051028-5
9041069-5	3/8"	SW11	50	30	22	19,5	9051069-5
9041070-5	3/8"	SW12	50	50	22	22	9051070-5
9041029-5	3/8"	SW13	50	28	25,5	22	9051029-5
9041071-5	3/8"	SW14	50	30	23,2	25	9051071-5
9041072-5	3/8"	SW15	50	50	26	26	9051072-5
9041041-5	3/8"	SW16	50	50	26	26	9051041-5
9041073-5	3/8"	SW17	50	50	26,8	26,8	9051073-5
9041074-5	3/8"	SW18	50	35	27	28,5	9051074-5
9041075-5	3/8"	SW19	50	35	27	29,5	9051075-5
9041076-5	3/8"	SW21	50	35	26	32	9051076-5
9041077-5	3/8"	SW22	50	34	26	33,4	9051077-5
9041078-5	3/8"	SW24	50	34	26	35	9051078-5

Nástrčná hlavice 6-ti hranná tenkostěnná L55

6-point socket thin walled L55



Kód	Pohon	Výstup	L	L1	D1	D	Náhr. pouzdra
Code	In-/	Output	L	L1	D1	D	Repl. Sleeves
9041108-55-10	3/8"	SW8	55	30	20	15	9051108-55-10
9041110-55-10	3/8"	SW10	55	32	20	17	9051110-55-10
9041111-55-10	3/8"	SW11	55	34	20	19	9051111-55-10
9041112-55-10	3/8"	SW12	55	55	20	20	9051112-55-10
9041113-55-10	3/8"	SW13	55	55	21	21	9051113-55-10
9041114-55-10	3/8"	SW14	55	55	23	23	9051114-55-10
9041115-55-10	3/8"	SW15	55	55	24	24	9051115-55-10
9041116-55-10	3/8"	SW16	55	55	25	25	9051116-55-10
9041117-55-10	3/8"	SW17	55	55	26,5	26,5	9051117-55-10
9041118-55-10	3/8"	SW18	55	55	27,5	27,5	9051118-55-10
9041119-55-10	3/8"	SW19	55	55	28,5	28,5	9051119-55-10

Nástrčná hlavice tenkostěnná L55, Torx

Socket thin walled L55, Torx



Kód	Pohon	Výstup	L	L1	D1	D	Náhr. pouzdra
Code	In-/	Output	L	L1	D1	D	Repl. Sleeves
90411E06-55-10	3/8"	E6	55	30	20	11	90511E06-55-10
90411E08-55-10	3/8"	E8	55	30	20	12,5	90511E08-55-10
90411E10-55-10	3/8"	E10	55	30	20	14,5	90511E10-55-10
90411E12-55-10	3/8"	E12	55	32	20	17	90511E12-55-10
90411E14-55-10	3/8"	E14	55	32	20	18,5	90511E14-55-10
90411E16-55-10	3/8"	E16	55	55	20,5	20,5	90511E16-55-10

Nástrčná hlavice dvojitý 6-ti hran L50, Pinch-point

12-point socket L50, Pinch-point



Kód	Pohon	Výstup	L	L1	D1	D	Náhr. pouzdra
Code	In-/	Output	L	L1	D1	D	Repl. Sleeves
9041067-5-pp	3/8"	SW8	50	25	22	16	9051067-5-pp
9041068-5-pp	3/8"	SW9	50	30	22	16,5	9051068-5-pp
9041028-5-pp	3/8"	SW10	50	26	22	18	9051028-5-pp
9041069-5-pp	3/8"	SW11	50	30	22	19,5	9051069-5-pp
9041070-5-pp	3/8"	SW12	50	50	22	22	9051070-5-pp
9041029-5-pp	3/8"	SW13	50	28	25,5	22	9051029-5-pp
9041071-5-pp	3/8"	SW14	50	30	23,2	25	9051071-5-pp
9041072-5-pp	3/8"	SW15	50	50	26	26	9051072-5-pp
9041041-5-pp	3/8"	SW16	50	50	26	26	9051041-5-pp
9041073-5-pp	3/8"	SW17	50	50	26,8	26,8	9051073-5-pp
9041074-5-pp	3/8"	SW18	50	35	27	28,5	9051074-5-pp
9041075-5-pp	3/8"	SW19	50	35	27	29,5	9051075-5-pp
9041076-5-pp	3/8"	SW21	50	35	26	32	9051076-5-pp
9041077-5-pp	3/8"	SW22	50	34	26	33,4	9051077-5-pp
9041078-5-pp	3/8"	SW24	50	34	26	35	9051078-5-pp



covertec 3/8"

Nástrčná hlavice 6-ti hranná tenkostěnná L55, Pinch-point
6-point socket thin walled L55, Pinch-point



Kód	Pohon	Výstup	L	L1	D1	D	Náhradní pouzdra
Code	In-/	Output	L	L1	D1	D	Repl. Sleeves
9041108-55-10-pp	3/8"	SW8	55	30	20	15	9051108-55-10-pp
9041110-55-10-pp	3/8"	SW10	55	32	20	17	9051110-55-10-pp
9041111-55-10-pp	3/8"	SW11	55	34	20	19	9051111-55-10-pp
9041112-55-10-pp	3/8"	SW12	55	55	20	20	9051112-55-10-pp
9041113-55-10-pp	3/8"	SW13	55	55	21	21	9051113-55-10-pp
9041114-55-10-pp	3/8"	SW14	55	55	23	23	9051114-55-10-pp
9041115-55-10-pp	3/8"	SW15	55	55	24	24	9051115-55-10-pp
9041116-55-10-pp	3/8"	SW16	55	55	25	25	9051116-55-10-pp
9041117-55-10-pp	3/8"	SW17	55	55	26,5	26,5	9051117-55-10-pp
9041118-55-10-pp	3/8"	SW18	55	55	27,5	27,5	9051118-55-10-pp
9041119-55-10-pp	3/8"	SW19	55	55	28,5	28,5	9051119-55-10-pp

Nástrčná hlavice tenkostěnná L55, Pinch-point, Torx
Socket thin walled L55, Pinch-point, Torx



Kód	Pohon	Výstup	L	L1	D1	D	Náhradní pouzdra
Code	In-/	Output	L	L1	D1	D	Repl. Sleeves
90411E06-55-10-pp	3/8"	E6	55	30	20	11	90511E06-55-10-pp
90411E08-55-10-pp	3/8"	E8	55	30	20	12,5	90511E08-55-10-pp
90411E10-55-10-pp	3/8"	E10	55	30	20	14,5	90511E10-55-10-pp
90411E12-55-10-pp	3/8"	E12	55	32	20	17	90511E12-55-10-pp
90411E14-55-10-pp	3/8"	E14	55	32	20	18,5	90511E14-55-10-pp
90411E16-55-10-pp	3/8"	E16	55	55	20,5	20,5	90511E16-55-10-pp

covertec nářadí

covertec tools

covertec 3/8"

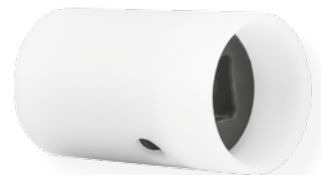
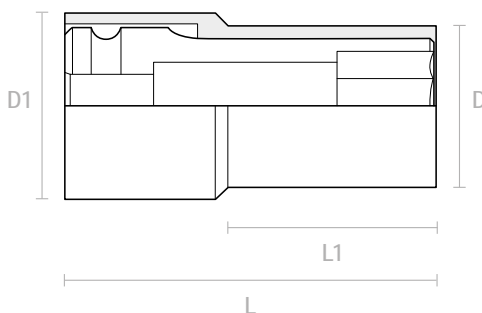

Pinch-point

Nástrčná hlavice 6-ti hranná L80 6-point socket L80



Kód	Pohon	Výstup	L	L1	D1	D	Náhr. pouzdra
Code	Input	Output	L	L1	D1	D	Repl. Sleeves
9041079	3/8"	SW8	80	53	22	16,8	9051079
9041080	3/8"	SW9	80	56	22	17,5	9051080
9041030	3/8"	SW10	80	56	22	19	9051030
9041081	3/8"	SW11	80	57	22	20	9051081
9041082	3/8"	SW12	80	80	22	22	9051082
9041031	3/8"	SW13	80	54	25	23	9051031
9041083	3/8"	SW14	80	80	26	26	9051083
9041084	3/8"	SW15	80	80	27	27	9051084
9041047	3/8"	SW16	80	80	27	27	9051047
9041032	3/8"	SW17	80	80	27	27	9051032
9041085	3/8"	SW18	80	70	27	29	9051085
9041086	3/8"	SW19	80	80	30	30	9051086
9041087	3/8"	SW21	80	67	27	34	9051087
9041088	3/8"	SW22	80	67	27	35	9051088
9041089	3/8"	SW24	80	67	27	36,5	9051089

Nástrčná hlavice 6-ti hranná L80, Pinch-point 6-point socket L80, Pinch-point



Kód	Pohon	Výstup	L	L1	D1	D	Náhr. pouzdra
Code	Input	Output	L	L1	D1	D	Repl. Sleeves
9041079-pp	3/8"	SW8	80	53	22	16,8	9051079-pp
9041080-pp	3/8"	SW9	80	56	22	17,5	9051080-pp
9041030-pp	3/8"	SW10	80	56	22	19	9051030-pp
9041081-pp	3/8"	SW11	80	57	22	20	9051081-pp
9041082-pp	3/8"	SW12	80	80	22	22	9051082-pp
9041031-pp	3/8"	SW13	80	54	25	23	9051031-pp
9041083-pp	3/8"	SW14	80	80	26	26	9051083-pp
9041084-pp	3/8"	SW15	80	80	27	27	9051084-pp
9041047-pp	3/8"	SW16	80	80	27	27	9051047-pp
9041032-pp	3/8"	SW17	80	80	27	27	9051032-pp
9041085-pp	3/8"	SW18	80	70	27	29	9051085-pp
9041086-pp	3/8"	SW19	80	80	30	30	9051086-pp
9041087-pp	3/8"	SW21	80	67	27	34	9051087-pp
9041088-pp	3/8"	SW22	80	67	27	35	9051088-pp
9041089-pp	3/8"	SW24	80	67	27	36,5	9051089-pp

Nástrčná hlavice L80, Torx Socket L80, Torx



Kód	Pohon	Výstup	L	L1	D1	D	Náhr. pouzdra
Code	Input	Output	L	L1	D1	D	Repl. Sleeves
9041033	3/8"	E10	80	56	22	19	9051033
9041034	3/8"	E12	80	56	22	19	9051034
9041035	3/8"	E14	80	80	22	22	9051035

Nástrčná hlavice L80, Pinch-point, Torx Socket L80, Pinch-point, Torx



Kód	Pohon	Výstup	L	L1	D1	D	Náhr. pouzdra
Code	Input	Output	L	L1	D1	D	Repl. Sleeves
9041033-pp	3/8"	E10	80	56	22	19	9051033-pp
9041034-pp	3/8"	E12	80	56	22	19	9051034-pp
9041035-pp	3/8"	E14	80	80	22	22	9051035-pp

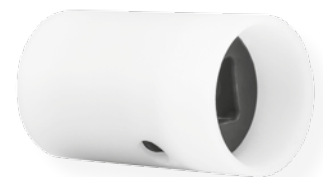
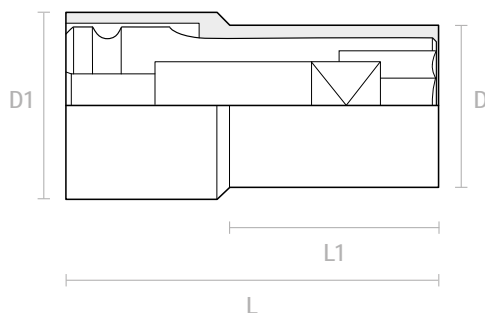

Pinch-point

Nástrčná hlavice 6-ti hranná s tyčovým magnetem L80
6-point socket with central magnet L80



Kód	Pohon	Výstup	L	L1	D1	D	Náhr. pouzdra
Code	Input	Output	L	L1	D1	D	Repl. Sleeves
9041079-1	3/8"	SW8	80	53	22	16,8	9051079-1
9041080-1	3/8"	SW9	80	56	22	17,5	9051080-1
9041030-1	3/8"	SW10	80	56	22	19	9051030-1
9041081-1	3/8"	SW11	80	57	22	20	9051081-1
9041082-1	3/8"	SW12	80	80	22	22	9051082-1
9041031-1	3/8"	SW13	80	54	25	23	9051031-1
9041083-1	3/8"	SW14	80	80	26	26	9051083-1
9041084-1	3/8"	SW15	80	80	27	27	9051084-1
9041047-1	3/8"	SW16	80	80	27	27	9051047-1
9041032-1	3/8"	SW17	80	80	27	27	9051032-1
9041085-1	3/8"	SW18	80	70	27	29	9051085-1
9041086-1	3/8"	SW19	80	80	30	30	9051086-1
9041087-1	3/8"	SW21	80	67	27	34	9051087-1
9041088-1	3/8"	SW22	80	67	27	35	9051088-1
9041089-1	3/8"	SW24	80	67	27	36,5	9051089-1

Nástrčná hlavice 6-ti hranná s tyčovým magnetem L80, Pinch-p.
6-point socket with central magnet L80, Pinch-point



Kód	Pohon	Výstup	L	L1	D1	D	Náhr. pouzdra
Code	Input	Output	L	L1	D1	D	Repl. Sleeves
9041079-1-pp	3/8"	SW8	80	53	22	16,8	9051079-1-pp
9041080-1-pp	3/8"	SW9	80	56	22	17,5	9051080-1-pp
9041030-1-pp	3/8"	SW10	80	56	22	19	9051030-1-pp
9041081-1-pp	3/8"	SW11	80	57	22	20	9051081-1-pp
9041082-1-pp	3/8"	SW12	80	80	22	22	9051082-1-pp
9041031-1-pp	3/8"	SW13	80	54	25	23	9051031-1-pp
9041083-1-pp	3/8"	SW14	80	80	26	26	9051083-1-pp
9041084-1-pp	3/8"	SW15	80	80	27	27	9051084-1-pp
9041047-1-pp	3/8"	SW16	80	80	27	27	9051047-1-pp
9041032-1-pp	3/8"	SW17	80	80	27	27	9051032-1-pp
9041085-1-pp	3/8"	SW18	80	70	27	29	9051085-1-pp
9041086-1-pp	3/8"	SW19	80	80	30	30	9051086-1-pp
9041087-1-pp	3/8"	SW21	80	67	27	34	9051087-1-pp
9041088-1-pp	3/8"	SW22	80	67	27	35	9051088-1-pp
9041089-1-pp	3/8"	SW24	80	67	27	36,5	9051089-1-pp

Nástrčná hlavice s tyčovým magnetem L80, Torx
Socket with central magnet L80, Torx



Kód	Pohon	Výstup	L	L1	D1	D	Náhr. pouzdra
Code	Input	Output	L	L1	D1	D	Repl. Sleeves
9041033-1	3/8"	E10	80	56	22	19	9051033-1
9041034-1	3/8"	E12	80	56	22	19	9051034-1
9041035-1	3/8"	E14	80	80	22	22	9051035-1

Nástrčná hlavice s tyčovým magnetem L80, Pinch-point, Torx
Socket with central magnet L80, Pinch-point, Torx



Kód	Pohon	Výstup	L	L1	D1	D	Náhr. pouzdra
Code	Input	Output	L	L1	D1	D	Repl. Sleeves
9041033-1-pp	3/8"	E10	80	56	22	19	9051033-1-pp
9041034-1-pp	3/8"	E12	80	56	22	19	9051034-1-pp
9041035-1-pp	3/8"	E14	80	80	22	22	9051035-1-pp

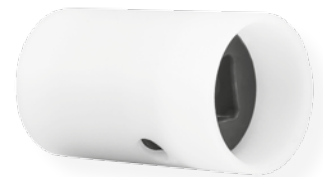
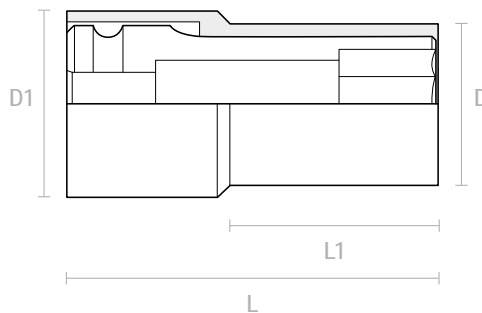

Pinch-point

Nástrčná hlavice 6-ti hranná 3 bodový magnet L80
6-point socket 3-point magnet L80



Kód	Pohon	Výstup	L	L1	D1	D	Náhr. pouzdra
Code	Input	Output	L	L1	D1	D	Repl. Sleeves
9041079-2	3/8"	SW8	80	53	22	16,8	9051079-2
9041080-2	3/8"	SW9	80	56	22	17,5	9051080-2
9041030-2	3/8"	SW10	80	56	22	19	9051030-2
9041081-2	3/8"	SW11	80	57	22	20	9051081-2
9041082-2	3/8"	SW12	80	80	22	22	9051082-2
9041031-2	3/8"	SW13	80	54	25	23	9051031-2
9041083-2	3/8"	SW14	80	80	26	26	9051083-2
9041084-2	3/8"	SW15	80	80	27	27	9051084-2
9041047-2	3/8"	SW16	80	80	27	27	9051047-2
9041032-2	3/8"	SW17	80	80	27	27	9051032-2
9041085-2	3/8"	SW18	80	70	27	29	9051085-2
9041086-2	3/8"	SW19	80	80	30	30	9051086-2
9041087-2	3/8"	SW21	80	67	27	34	9051087-2
9041088-2	3/8"	SW22	80	67	27	35	9051088-2
9041089-2	3/8"	SW24	80	67	27	36,5	9051089-2

Nástrčná hlavice Surface-drive L80
Socket surface-drive L80



Kód	Pohon	Výstup	L	L1	D1	D	Náhr. pouzdra
Code	Input	Output	L	L1	D1	D	Repl. Sleeves
9041079-4	3/8"	SW8sd	80	53	22	16,8	9051079-4
9041080-4	3/8"	SW9sd	80	56	22	17,5	9051080-4
9041030-4	3/8"	SW10sd	80	56	22	19	9051030-4
9041081-4	3/8"	SW11sd	80	57	22	20	9051081-4
9041082-4	3/8"	SW12sd	80	80	22	22	9051082-4
9041031-4	3/8"	SW13sd	80	54	25	23	9051031-4
9041083-4	3/8"	SW14sd	80	80	26	26	9051083-4
9041084-4	3/8"	SW15sd	80	80	27	27	9051084-4
9041047-4	3/8"	SW16sd	80	80	27	27	9051047-4
9041032-4	3/8"	SW17sd	80	80	27	27	9051032-4
9041085-4	3/8"	SW18sd	80	70	27	29	9051085-4
9041086-4	3/8"	SW19sd	80	80	30	30	9051086-4
9041087-4	3/8"	SW21sd	80	67	27	34	9051087-4
9041088-4	3/8"	SW22sd	80	67	27	35	9051088-4
9041089-4	3/8"	SW24sd	80	67	27	36,5	9051089-4

Nástrčná hlavice 6-ti hranná 3 bodový magnet L80, Pinch-point
6-point socket 3-point magnet L80, Pinch-point



Kód	Pohon	Výstup	L	L1	D1	D	Náhr. pouzdra
Code	Input	Output	L	L1	D1	D	Repl. Sleeves
9041079-2-pp	3/8"	SW8	80	53	22	16,8	9051079-2-pp
9041080-2-pp	3/8"	SW9	80	56	22	17,5	9051080-2-pp
9041030-2-pp	3/8"	SW10	80	56	22	19	9051030-2-pp
9041081-2-pp	3/8"	SW11	80	57	22	20	9051081-2-pp
9041082-2-pp	3/8"	SW12	80	80	22	22	9051082-2-pp
9041031-2-pp	3/8"	SW13	80	54	25	23	9051031-2-pp
9041083-2-pp	3/8"	SW14	80	80	26	26	9051083-2-pp
9041084-2-pp	3/8"	SW15	80	80	27	27	9051084-2-pp
9041047-2-pp	3/8"	SW16	80	80	27	27	9051047-2-pp
9041032-2-pp	3/8"	SW17	80	80	27	27	9051032-2-pp
9041085-2-pp	3/8"	SW18	80	70	27	29	9051085-2-pp
9041086-2-pp	3/8"	SW19	80	80	30	30	9051086-2-pp
9041087-2-pp	3/8"	SW21	80	67	27	34	9051087-2-pp
9041088-2-pp	3/8"	SW22	80	67	27	35	9051088-2-pp
9041089-2-pp	3/8"	SW24	80	67	27	36,5	9051089-2-pp

Nástrčná hlavice Surface-drive L80, Pinch-point
Socket surface-drive L80, Pinch-point



Kód	Pohon	Výstup	L	L1	D1	D	Náhr. pouzdra
Code	Input	Output	L	L1	D1	D	Repl. Sleeves
9041079-4-pp	3/8"	SW8sd	80	53	22	16,8	9051079-4-pp
9041080-4-pp	3/8"	SW9sd	80	56	22	17,5	9051080-4-pp
9041030-4-pp	3/8"	SW10sd	80	56	22	19	9051030-4-pp
9041081-4-pp	3/8"	SW11sd	80	57	22	20	9051081-4-pp
9041082-4-pp	3/8"	SW12sd	80	80	22	22	9051082-4-pp
9041031-4-pp	3/8"	SW13sd	80	54	25	23	9051031-4-pp
9041083-4-pp	3/8"	SW14sd	80	80	26	26	9051083-4-pp
9041084-4-pp	3/8"	SW15sd	80	80	27	27	9051084-4-pp
9041047-4-pp	3/8"	SW16sd	80	80	27	27	9051047-4-pp
9041032-4-pp	3/8"	SW17sd	80	80	27	27	9051032-4-pp
9041085-4-pp	3/8"	SW18sd	80	70	27	29	9051085-4-pp
9041086-4-pp	3/8"	SW19sd	80	80	30	30	9051086-4-pp
9041087-4-pp	3/8"	SW21sd	80	67	27	34	9051087-4-pp
9041088-4-pp	3/8"	SW22sd	80	67	27	35	9051088-4-pp
9041089-4-pp	3/8"	SW24sd	80	67	27	36,5	9051089-4-pp

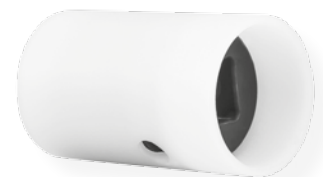
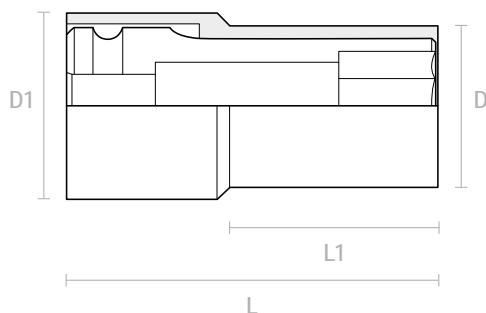

Pinch-point

Nástrčná hlavice dvojitý 6-ti hran L80

12-point socket L80



Kód	Pohon	Výstup	L	L1	D1	D	Náhr. pouzdra
Code	Input	Output	L	L1	D1	D	Repl. Sleeves
9041079-5	3/8"	SW8	80	53	22	16,8	9051079-5
9041080-5	3/8"	SW9	80	56	22	17,5	9051080-5
9041030-5	3/8"	SW10	80	56	22	19	9051030-5
9041081-5	3/8"	SW11	80	57	22	20	9051081-5
9041082-5	3/8"	SW12	80	80	22	22	9051082-5
9041031-5	3/8"	SW13	80	54	25	23	9051031-5
9041083-5	3/8"	SW14	80	80	26	26	9051083-5
9041084-5	3/8"	SW15	80	80	27	27	9051084-5
9041047-5	3/8"	SW16	80	80	27	27	9051047-5
9041032-5	3/8"	SW17	80	80	27	27	9051032-5
9041085-5	3/8"	SW18	80	70	27	29	9051085-5
9041086-5	3/8"	SW19	80	80	30	30	9051086-5
9041087-5	3/8"	SW21	80	67	27	34	9051087-5
9041088-5	3/8"	SW22	80	67	27	35	9051088-5
9041089-5	3/8"	SW24	80	67	27	36,5	9051089-5

Nástrčná hlavice dvojitý 6-ti hran L80, Pinch-point

12-point socket L80, Pinch-point



Kód	Pohon	Výstup	L	L1	D1	D	Náhr. pouzdra
Code	Input	Output	L	L1	D1	D	Repl. Sleeves
9041079-5-pp	3/8"	SW8	80	53	22	16,8	9051079-5-pp
9041080-5-pp	3/8"	SW9	80	56	22	17,5	9051080-5-pp
9041030-5-pp	3/8"	SW10	80	56	22	19	9051030-5-pp
9041081-5-pp	3/8"	SW11	80	57	22	20	9051081-5-pp
9041082-5-pp	3/8"	SW12	80	80	22	22	9051082-5-pp
9041031-5-pp	3/8"	SW13	80	54	25	23	9051031-5-pp
9041083-5-pp	3/8"	SW14	80	80	26	26	9051083-5-pp
9041084-5-pp	3/8"	SW15	80	80	27	27	9051084-5-pp
9041047-5-pp	3/8"	SW16	80	80	27	27	9051047-5-pp
9041032-5-pp	3/8"	SW17	80	80	27	27	9051032-5-pp
9041085-5-pp	3/8"	SW18	80	70	27	29	9051085-5-pp
9041086-5-pp	3/8"	SW19	80	80	30	30	9051086-5-pp
9041087-5-pp	3/8"	SW21	80	67	27	34	9051087-5-pp
9041088-5-pp	3/8"	SW22	80	67	27	35	9051088-5-pp
9041089-5-pp	3/8"	SW24	80	67	27	36,5	9051089-5-pp



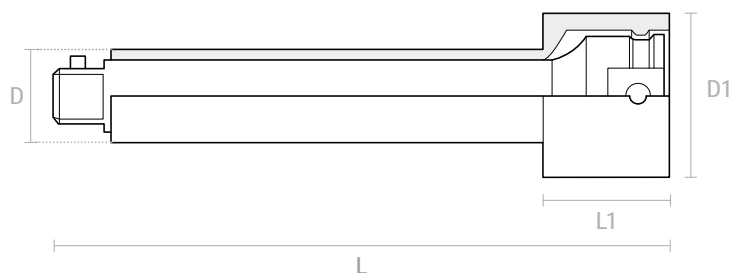

Prodloužení 3/8"

Extension 3/8"



Kód	Pohon	Výstup	L	L1	D1	D	Náhr. pouzdra
Code	Input	Output	L	L1	D1	D	Repl. Sleeves
9060004	3/8"	3/8"	75	26	28	16	9061004
9060052	3/8"	3/8"	90	26	28	16	9061052
9060051	3/8"	3/8"	100	26	28	16	9061051
9060005	3/8"	3/8"	125	26	28	16	9061005
9060035	3/8"	3/8"	150	26	28	16	9061035
9060038	3/8"	3/8"	160	26	28	16	9061038
9060056	3/8"	3/8"	180	26	28	16	9061056
9060050	3/8"	3/8"	200	26	28	16	9061050
9060006	3/8"	3/8"	250	26	28	16	9061006
9060037	3/8"	3/8"	380	26	28	16	9061037
9060036	3/8"	3/8"	400	26	28	16	9061036
9060039	3/8"	3/8"	450	26	28	16	9061039
9060055	3/8"	3/8"	480	26	28	16	9061055
9060053	3/8"	3/8"	500	26	28	16	9061053
9060054	3/8"	3/8"	510	26	28	16	9061054



Prodloužení tenkostěnné 3/8"

Extension thin walled 3/8"



Kód	Pohon	Výstup	L	L1	D1	D	Náhr. pouzdra
Code	Input	Output	L	L1	D1	D	Repl. Sleeves
9060004-10	3/8"	3/8"	75	25	21	16	9061004-10
9060005-10	3/8"	3/8"	125	25	21	16	9061005-10
9060006-10	3/8"	3/8"	250	25	21	16	9061006-10

covertec 3/8"

covertec nářadí

covertec tools

covertec 3/8"

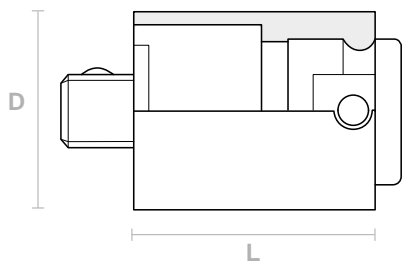

Rychlovýměnné sklíčidlo 3/8"

Quick-release 3/8"



Kód	Pohon	Výstup	D	L
Code	Input	Output	D	L
9092002	3/8"	E11	36	55
9092003	3/8"	C8	25	45
9092004	3/8"	E6,3	25	45
9092005	3/8"	3/8"	26	45
9092011	3/8"	E11	36	45



Držák bitů s tyčovým magnetem 3/8"

Bit holder with central magnet 3/8"



Kód	Pohon	Výstup	L	L1	D1	D	Bit
Code	Input	Output	L	L1	D1	D	Bit
9091012-2	3/8"	C6,3	35,5	35,5	22	22	C6,3 / E6,3
9091012-1	3/8"	C8	35,5	35,5	22	22	C8



covertec 1/2"

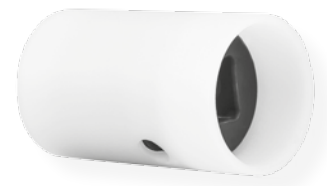
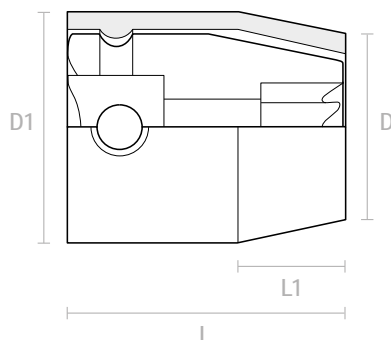

Pinch-point

covertec 1/2"

Nástrčná hlavice 6-ti hranná L38 6-point socket L38



Kód	Pohon	Výstup	L	L1	D1	D	Náhr. pouzdra
Code	Input	Output	L	L1	D1	D	Repl. Sleeves
9041090	1/2"	SW8	38	18	28	16,5	9051090
9041091	1/2"	SW9	38	18	28	18	9051091
9041050	1/2"	SW10	38	18	28	19	9051050
9041051	1/2"	SW11	38	18	28	20,5	9051051
9041094	1/2"	SW12	38	18	29	23,6	9051094
9041019	1/2"	SW13	38	16	28	25	9051019
9041020	1/2"	SW14	38	14	28	25,5	9051020
9041021	1/2"	SW15	38	17	34	28	9051021
9041022	1/2"	SW16	38	14	34	28	9051022
9041023	1/2"	SW17	38	13,5	34	30	9051023
9041042	1/2"	SW18	38	13,5	34	30	9051042
9041024	1/2"	SW19	38	38	34	34	9051024
9041037	1/2"	SW21	38	38	34	34	9051037
9041095	1/2"	SW22	38	38	34	34	9051095
9041096	1/2"	SW24	38	25	34	27,5	9051096
9041097	1/2"	SW27	40	23	34	42	9051097
9041098	1/2"	SW30	40	23	34	46	9051098

Nástrčná hlavice 6-ti hranná L38, Pinch-point 6-point socket L38, Pinch-point



Kód	Pohon	Výstup	L	L1	D1	D	Náhr. pouzdra
Code	Input	Output	L	L1	D1	D	Repl. Sleeves
9041090-pp	1/2"	SW8	38	18	28	16,5	9051090-pp
9041091-pp	1/2"	SW9	38	18	28	18	9051091-pp
9041050-pp	1/2"	SW10	38	18	28	19	9051050-pp
9041051-pp	1/2"	SW11	38	18	28	20,5	9051051-pp
9041094-pp	1/2"	SW12	38	18	29	23,6	9051094-pp
9041019-pp	1/2"	SW13	38	16	28	25	9051019-pp
9041020-pp	1/2"	SW14	38	14	28	25,5	9051020-pp
9041021-pp	1/2"	SW15	38	17	34	28	9051021-pp
9041022-pp	1/2"	SW16	38	14	34	28	9051022-pp
9041023-pp	1/2"	SW17	38	13,5	34	30	9051023-pp
9041042-pp	1/2"	SW18	38	13,5	34	30	9051042-pp
9041024-pp	1/2"	SW19	38	38	34	34	9051024-pp
9041037-pp	1/2"	SW21	38	38	34	34	9051037-pp
9041095-pp	1/2"	SW22	38	38	34	34	9051095-pp
9041096-pp	1/2"	SW24	38	25	34	27,5	9051096-pp
9041097-pp	1/2"	SW27	40	23	34	42	9051097-pp
9041098-pp	1/2"	SW30	40	23	34	46	9051098-pp

Nástrčná hlavice L38, Torx Socket L38, Torx



Kód	Pohon	Výstup	L	L1	D1	D	Náhr. pouzdra
Code	Input	Output	L	L1	D1	D	Repl. Sleeves
9041190	1/2"	E10	38	17	28	17	9051190
9041025	1/2"	E12	38	17	28	18	9051025
9041026	1/2"	E14	38	12	28	22	9051026
9041054	1/2"	E16	38	19	28	22,5	9051054
9041027	1/2"	E18	38	10	28	25,5	9051027
9041192	1/2"	E20	38	9	34	30,5	9051192

Nástrčná hlavice L38, Pinch-point, Torx Socket L38, Pinch-point, Torx



Kód	Pohon	Výstup	L	L1	D1	D	Náhr. pouzdra
Code	Input	Output	L	L1	D1	D	Repl. Sleeves
9041190-pp	1/2"	E10	38	17	28	17	9051190-pp
9041025-pp	1/2"	E12	38	17	28	18	9051025-pp
9041026-pp	1/2"	E14	38	12	28	22	9051026-pp
9041054-pp	1/2"	E16	38	19	28	22,5	9051054-pp
9041027-pp	1/2"	E18	38	10	28	25,5	9051027-pp
9041192-pp	1/2"	E20	38	9	34	30,5	9051192-pp

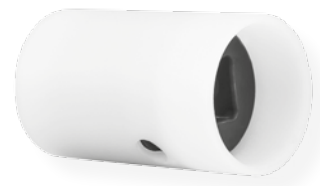
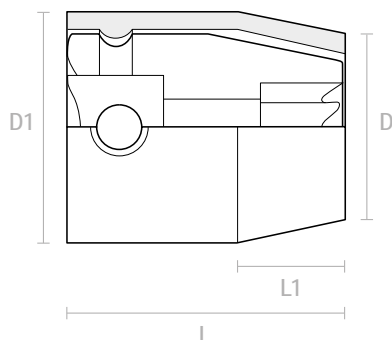

Pinch-point

Nástrčná hlavice 6-ti hranná s tyčovým magnetem L38
6-point socket with central magnet L38



Kód	Pohon	Výstup	L	L1	D1	D	Náhr. pouzdra
Code	Input	Output	L	L1	D1	D	Repl. Sleeves
9041090-1	1/2"	SW8	38	18	28	16,5	9051090-1
9041091-1	1/2"	SW9	38	18	28	18	9051091-1
9041050-1	1/2"	SW10	38	18	28	19	9051050-1
9041051-1	1/2"	SW11	38	18	28	20,5	9051051-1
9041094-1	1/2"	SW12	38	18	29	23,6	9051094-1
9041019-1	1/2"	SW13	38	16	28	25	9051019-1
9041020-1	1/2"	SW14	38	14	28	25,5	9051020-1
9041021-1	1/2"	SW15	38	17	34	28	9051021-1
9041022-1	1/2"	SW16	38	14	34	28	9051022-1
9041023-1	1/2"	SW17	38	13,5	34	30	9051023-1
9041042-1	1/2"	SW18	38	13,5	34	30	9051042-1
9041024-1	1/2"	SW19	38	38	34	34	9051024-1
9041037-1	1/2"	SW21	38	38	34	34	9051037-1
9041095-1	1/2"	SW22	38	38	34	34	9051095-1
9041096-1	1/2"	SW24	38	25	34	27,5	9051096-1
9041097-1	1/2"	SW27	40	23	34	42	9051097-1
9041098-1	1/2"	SW30	40	23	34	46	9051098-1

Nástrčná hlavice 6-ti hranná s tyčovým magnetem L38, Pinch-p.
6-point socket with central magnet L38, Pinch-point



Kód	Pohon	Výstup	L	L1	D1	D	Náhr. pouzdra
Code	Input	Output	L	L1	D1	D	Repl. Sleeves
9041090-1-pp	1/2"	SW8	38	18	28	16,5	9051090-1-pp
9041091-1-pp	1/2"	SW9	38	18	28	18	9051091-1-pp
9041050-1-pp	1/2"	SW10	38	18	28	19	9051050-1-pp
9041051-1-pp	1/2"	SW11	38	18	28	20,5	9051051-1-pp
9041094-1-pp	1/2"	SW12	38	18	29	23,6	9051094-1-pp
9041019-1-pp	1/2"	SW13	38	16	28	25	9051019-1-pp
9041020-1-pp	1/2"	SW14	38	14	28	25,5	9051020-1-pp
9041021-1-pp	1/2"	SW15	38	17	34	28	9051021-1-pp
9041022-1-pp	1/2"	SW16	38	14	34	28	9051022-1-pp
9041023-1-pp	1/2"	SW17	38	13,5	34	30	9051023-1-pp
9041042-1-pp	1/2"	SW18	38	13,5	34	30	9051042-1-pp
9041024-1-pp	1/2"	SW19	38	38	34	34	9051024-1-pp
9041037-1-pp	1/2"	SW21	38	38	34	34	9051037-1-pp
9041095-1-pp	1/2"	SW22	38	38	34	34	9051095-1-pp
9041096-1-pp	1/2"	SW24	38	25	34	27,5	9051096-1-pp
9041097-1-pp	1/2"	SW27	40	23	34	42	9051097-1-pp
9041098-1-pp	1/2"	SW30	40	23	34	46	9051098-1-pp

Nástrčná hlavice s tyčovým magnetem L38, Torx
Socket with central magnet L38, Torx



Kód	Pohon	Výstup	L	L1	D1	D	Náhr. pouzdra
Code	Input	Output	L	L1	D1	D	Repl. Sleeves
9041190-1	1/2"	E10	38	17	28	17	9051190-1
9041025-1	1/2"	E12	38	17	28	18	9051025-1
9041026-1	1/2"	E14	38	12	28	22	9051026-1
9041054-1	1/2"	E16	38	19	28	22,5	9051054-1
9041027-1	1/2"	E18	38	10	28	25,5	9051027-1
9041192-1	1/2"	E20	38	9	34	30,5	9051192-1

Nástrčná hlavice s tyčovým magnetem L38, Pinch-point, Torx
Socket with central magnet L38, Pinch-point, Torx



Kód	Pohon	Výstup	L	L1	D1	D	Náhr. pouzdra
Code	Input	Output	L	L1	D1	D	Repl. Sleeves
9041190-1-pp	1/2"	E10	38	17	28	17	9051190-1-pp
9041025-1-pp	1/2"	E12	38	17	28	18	9051025-1-pp
9041026-1-pp	1/2"	E14	38	12	28	22	9051026-1-pp
9041054-1-pp	1/2"	E16	38	19	28	22,5	9051054-1-pp
9041027-1-pp	1/2"	E18	38	10	28	25,5	9051027-1-pp
9041192-1-pp	1/2"	E20	38	9	34	30,5	9051192-1-pp

covertec nářadí

covertec tools

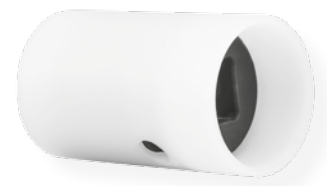
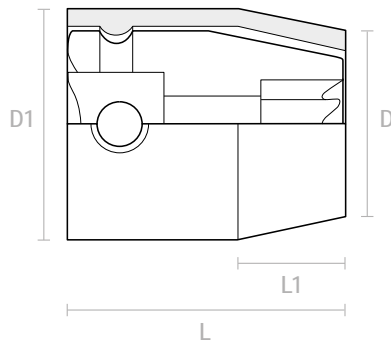

Pinch-point

Nástrčná hlavice 6-ti hranná 3 bodový magnet L38
6-point socket 3-point magnet L38



Nástrčná hlavice Surface-drive L38
Socket surface-drive L38



Kód	Pohon	Výstup	L	L1	D1	D	Náhr. pouzdra
Code	Input	Output	L	L1	D1	D	Repl. Sleeves
9041090-2	1/2"	SW8	38	18	28	16,5	9051090-2
9041091-2	1/2"	SW9	38	18	28	18	9051091-2
9041050-2	1/2"	SW10	38	18	28	19	9051050-2
9041051-2	1/2"	SW11	38	18	28	20,5	9051051-2
9041094-2	1/2"	SW12	38	18	29	23,6	9051094-2
9041019-2	1/2"	SW13	38	16	28	25	9051019-2
9041020-2	1/2"	SW14	38	14	28	25,5	9051020-2
9041021-2	1/2"	SW15	38	17	34	28	9051021-2
9041022-2	1/2"	SW16	38	14	34	28	9051022-2
9041023-2	1/2"	SW17	38	13,5	34	30	9051023-2
9041042-2	1/2"	SW18	38	13,5	34	30	9051042-2
9041024-2	1/2"	SW19	38	38	34	34	9051024-2
9041037-2	1/2"	SW21	38	38	34	34	9051037-2
9041095-2	1/2"	SW22	38	38	34	34	9051095-2
9041096-2	1/2"	SW24	38	25	34	27,5	9051096-2
9041097-2	1/2"	SW27	40	23	34	42	9051097-2
9041098-2	1/2"	SW30	40	23	34	46	9051098-2

Kód	Pohon	Výstup	L	L1	D1	D	Náhr. pouzdra
Code	Input	Output	L	L1	D1	D	Repl. Sleeves
9041090-4	1/2"	SW8sd	38	18	28	16,5	9051090-4
9041091-4	1/2"	SW9sd	38	18	28	18	9051091-4
9041050-4	1/2"	SW10sd	38	18	28	19	9051050-4
9041051-4	1/2"	SW11sd	38	18	28	20,5	9051051-4
9041094-4	1/2"	SW12sd	38	18	29	23,6	9051094-4
9041019-4	1/2"	SW13sd	38	16	28	25	9051019-4
9041020-4	1/2"	SW14sd	38	14	28	25,5	9051020-4
9041021-4	1/2"	SW15sd	38	17	34	28	9051021-4
9041022-4	1/2"	SW16sd	38	14	34	28	9051022-4
9041023-4	1/2"	SW17sd	38	13,5	34	30	9051023-4
9041042-4	1/2"	SW18sd	38	13,5	34	30	9051042-4
9041024-4	1/2"	SW19sd	38	38	34	34	9051024-4
9041037-4	1/2"	SW21sd	38	38	34	34	9051037-4
9041095-4	1/2"	SW22sd	38	38	34	34	9051095-4
9041096-4	1/2"	SW24sd	38	25	34	27,5	9051096-4
9041097-4	1/2"	SW27sd	40	23	34	42	9051097-4
9041098-4	1/2"	SW30sd	40	23	34	46	9051098-4

Nástrčná hlavice 6-ti hranná 3 bodový magnet L38, Pinch-point
6-point socket 3-point magnet L38, Pinch-point



Nástrčná hlavice Surface-drive L38, Pinch-point
Socket surface-drive L38, Pinch-point



Kód	Pohon	Výstup	L	L1	D1	D	Náhr. pouzdra
Code	Input	Output	L	L1	D1	D	Repl. Sleeves
9041090-2-pp	1/2"	SW8	38	18	28	16,5	9051090-2-pp
9041091-2-pp	1/2"	SW9	38	18	28	18	9051091-2-pp
9041050-2-pp	1/2"	SW10	38	18	28	19	9051050-2-pp
9041051-2-pp	1/2"	SW11	38	18	28	20,5	9051051-2-pp
9041094-2-pp	1/2"	SW12	38	18	29	23,6	9051094-2-pp
9041019-2-pp	1/2"	SW13	38	16	28	25	9051019-2-pp
9041020-2-pp	1/2"	SW14	38	14	28	25,5	9051020-2-pp
9041021-2-pp	1/2"	SW15	38	17	34	28	9051021-2-pp
9041022-2-pp	1/2"	SW16	38	14	34	28	9051022-2-pp
9041023-2-pp	1/2"	SW17	38	13,5	34	30	9051023-2-pp
9041042-2-pp	1/2"	SW18	38	13,5	34	30	9051042-2-pp
9041024-2-pp	1/2"	SW19	38	38	34	34	9051024-2-pp
9041037-2-pp	1/2"	SW21	38	38	34	34	9051037-2-pp
9041095-2-pp	1/2"	SW22	38	38	34	34	9051095-2-pp
9041096-2-pp	1/2"	SW24	38	25	34	27,5	9051096-2-pp
9041097-2-pp	1/2"	SW27	40	23	34	42	9051097-2-pp
9041098-2-pp	1/2"	SW30	40	23	34	46	9051098-2-pp

Kód	Pohon	Výstup	L	L1	D1	D	Náhr. pouzdra
Code	Input	Output	L	L1	D1	D	Repl. Sleeves
9041090-4-pp	1/2"	SW8sd	38	18	28	16,5	9051090-4-pp
9041091-4-pp	1/2"	SW9sd	38	18	28	18	9051091-4-pp
9041050-4-pp	1/2"	SW10sd	38	18	28	19	9051050-4-pp
9041051-4-pp	1/2"	SW11sd	38	18	28	20,5	9051051-4-pp
9041094-4-pp	1/2"	SW12sd	38	18	29	23,6	9051094-4-pp
9041019-4-pp	1/2"	SW13sd	38	16	28	25	9051019-4-pp
9041020-4-pp	1/2"	SW14sd	38	14	28	25,5	9051020-4-pp
9041021-4-pp	1/2"	SW15sd	38	17	34	28	9051021-4-pp
9041022-4-pp	1/2"	SW16sd	38	14	34	28	9051022-4-pp
9041023-4-pp	1/2"	SW17sd	38	13,5	34	30	9051023-4-pp
9041042-4-pp	1/2"	SW18sd	38	13,5	34	30	9051042-4-pp
9041024-4-pp	1/2"	SW19sd	38	38	34	34	9051024-4-pp
9041037-4-pp	1/2"	SW21sd	38	38	34	34	9051037-4-pp
9041095-4-pp	1/2"	SW22sd	38	38	34	34	9051095-4-pp
9041096-4-pp	1/2"	SW24sd	38	25	34	27,5	9051096-4-pp
9041097-4-pp	1/2"	SW27sd	40	23	34	42	9051097-4-pp
9041098-4-pp	1/2"	SW30sd	40	23	34	46	9051098-4-pp

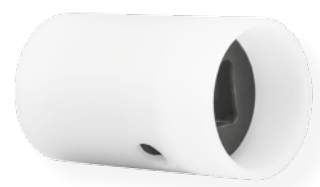
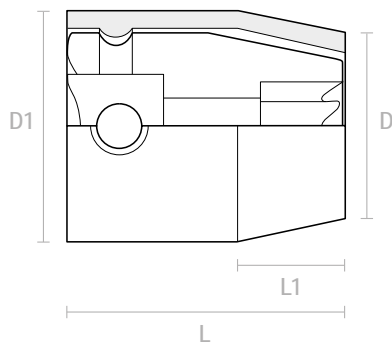

Pinch-point

Nástrčná hlavice dvojitý 6-ti hran L38
12-point socket L38



Kód	Pohon	Výstup	L	L1	D1	D	Náhr. pouzdra
Code	Input	Output	L	L1	D1	D	Repl. Sleeves
9041090-5	1/2"	SW8	38	18	28	16,5	9051090-5
9041091-5	1/2"	SW9	38	18	28	18	9051091-5
9041050-5	1/2"	SW10	38	18	28	19	9051050-5
9041051-5	1/2"	SW11	38	18	28	20,5	9051051-5
9041094-5	1/2"	SW12	38	18	29	23,6	9051094-5
9041019-5	1/2"	SW13	38	16	28	25	9051019-5
9041020-5	1/2"	SW14	38	14	28	25,5	9051020-5
9041021-5	1/2"	SW15	38	17	34	28	9051021-5
9041022-5	1/2"	SW16	38	14	34	28	9051022-5
9041023-5	1/2"	SW17	38	13,5	34	30	9051023-5
9041042-5	1/2"	SW18	38	13,5	34	30	9051042-5
9041024-5	1/2"	SW19	38	38	34	34	9051024-5
9041037-5	1/2"	SW21	38	38	34	34	9051037-5
9041095-5	1/2"	SW22	38	38	34	34	9051095-5
9041096-5	1/2"	SW24	38	25	34	27,5	9051096-5
9041097-5	1/2"	SW27	40	23	34	42	9051097-5
9041098-5	1/2"	SW30	40	23	34	46	9051098-5

Nástrčná hlavice 6-ti hranná tenkostěnná
6-point socket thin walled



Kód	Pohon	Výstup	L	L1	D1	D	Náhr. pouzdra
Code	Input	Output	L	L1	D1	D	Repl. Sleeves
9041210-37-10	1/2"	SW10	37	9	24	18	9051210-37-10
9041211-37-10	1/2"	SW11	37	10	24	19,5	9051211-37-10
9041212-37-10	1/2"	SW12	37	10,5	24	21	9051212-37-10
9041213-37-10	1/2"	SW13	37	11	25	22	9051213-37-10
9041214-37-10	1/2"	SW14	37	12	25	23,5	9051214-37-10
9041215-37-10	1/2"	SW15	37	12	25	24,5	9051215-37-10
9041216-37-10	1/2"	SW16	37	37	26	26	9051216-37-10
9041217-37-10	1/2"	SW17	37	37	27	27	9051217-37-10
9041218-37-10	1/2"	SW18	37	37	28	28	9051218-37-10
9041219-38-10	1/2"	SW19	38	38	30	30	9051219-38-10
9041220-38-10	1/2"	SW20	38	38	31	31	9051220-38-10
9041221-38-10	1/2"	SW21	38	38	32	32	9051221-38-10
9041222-40-10	1/2"	SW22	40	40	33	33	9051222-40-10
9041224-42-10	1/2"	SW24	42	42	36	36	9051224-42-10
9041227-43-10	1/2"	SW27	43	43	40	40	9051227-43-10
9041230-46-10	1/2"	SW30	46	46	43,5	43,5	9051230-46-10
9041232-46-10	1/2"	SW32	46	46	46,5	46,5	9051232-46-10

Nástrčná hlavice dvojitý 6-ti hran L38, Pinch-point
12-point socket L38, Pinch-point



Kód	Pohon	Výstup	L	L1	D1	D	Náhr. pouzdra
Code	Input	Output	L	L1	D1	D	Repl. Sleeves
9041090-5-pp	1/2"	SW8	38	18	28	16,5	9051090-5-pp
9041091-5-pp	1/2"	SW9	38	18	28	18	9051091-5-pp
9041050-5-pp	1/2"	SW10	38	18	28	19	9051050-5-pp
9041051-5-pp	1/2"	SW11	38	18	28	20,5	9051051-5-pp
9041094-5-pp	1/2"	SW12	38	18	29	23,6	9051094-5-pp
9041019-5-pp	1/2"	SW13	38	16	28	25	9051019-5-pp
9041020-5-pp	1/2"	SW14	38	14	28	25,5	9051020-5-pp
9041021-5-pp	1/2"	SW15	38	17	34	28	9051021-5-pp
9041022-5-pp	1/2"	SW16	38	14	34	28	9051022-5-pp
9041023-5-pp	1/2"	SW17	38	13,5	34	30	9051023-5-pp
9041042-5-pp	1/2"	SW18	38	13,5	34	30	9051042-5-pp
9041024-5-pp	1/2"	SW19	38	38	34	34	9051024-5-pp
9041037-5-pp	1/2"	SW21	38	38	34	34	9051037-5-pp
9041095-5-pp	1/2"	SW22	38	38	34	34	9051095-5-pp
9041096-5-pp	1/2"	SW24	38	25	34	27,5	9051096-5-pp
9041097-5-pp	1/2"	SW27	40	23	34	42	9051097-5-pp
9041098-5-pp	1/2"	SW30	40	23	34	46	9051098-5-pp

Nástrčná hlavice 6-ti hranná, tenkostěnná, Pinch-point
6-point socket thin walled, Pinch-point



Kód	Pohon	Výstup	L	L1	D1	D	Náhr. pouzdra
Code	Input	Output	L	L1	D1	D	Repl. Sleeves
9041210-37-10-pp	1/2"	SW10	37	9	24	18	9051210-37-10-pp
9041211-37-10-pp	1/2"	SW11	37	10	24	19,5	9051211-37-10-pp
9041212-37-10-pp	1/2"	SW12	37	10,5	24	21	9051212-37-10-pp
9041213-37-10-pp	1/2"	SW13	37	11	25	22	9051213-37-10-pp
9041214-37-10-pp	1/2"	SW14	37	12	25	23,5	9051214-37-10-pp
9041215-37-10-pp	1/2"	SW15	37	12	25	24,5	9051215-37-10-pp
9041216-37-10-pp	1/2"	SW16	37	37	26	26	9051216-37-10-pp
9041217-37-10-pp	1/2"	SW17	37	37	27	27	9051217-37-10-pp
9041218-37-10-pp	1/2"	SW18	37	37	28	28	9051218-37-10-pp
9041219-38-10-pp	1/2"	SW19	38	38	30	30	9051219-38-10-pp
9041220-38-10-pp	1/2"	SW20	38	38	31	31	9051220-38-10-pp
9041221-38-10-pp	1/2"	SW21	38	38	32	32	9051221-38-10-pp
9041222-40-10-pp	1/2"	SW22	40	40	33	33	9051222-40-10-pp
9041224-42-10-pp	1/2"	SW24	42	42	36	36	9051224-42-10-pp
9041227-43-10-pp	1/2"	SW27	43	43	40	40	9051227-43-10-pp
9041230-46-10-pp	1/2"	SW30	46	46	43,5	43,5	9051230-46-10-pp
9041232-46-10-pp	1/2"	SW32	46	46	46,5	46,5	9051232-46-10-pp

covertec nářadí

covertec tools

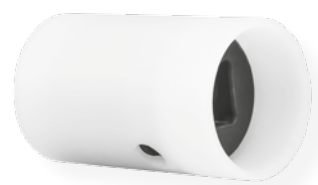
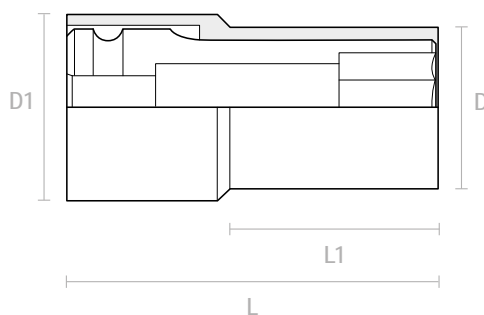

Pinch-point

covertec 1/2"

Nástrčná hlavice 6-ti hranná L60 6-point socket L60



Kód	Pohon	Výstup	L	L1	D1	D	Náhr. pouzdra
Code	Input	Output	L	L1	D1	D	Repl. Sleeves
9041099	1/2"	SW8	60	32	27,5	16,8	9051099
9041100	1/2"	SW9	60	32	27,5	17,9	9051100
9041101	1/2"	SW10	60	34	27,5	19,3	9051101
9041102	1/2"	SW11	60	34	27,5	20,5	9051102
9041103	1/2"	SW12	60	34	27,5	21,8	9051103
9041104	1/2"	SW13	60	35	27,5	23	9051104
9041105	1/2"	SW14	60	36	27,5	24,3	9051105
9041106	1/2"	SW15	60	32	32	24,8	9051106
9041107	1/2"	SW16	60	34	32	26	9051107
9041108	1/2"	SW17	60	35	32	27	9051108
9041109	1/2"	SW18	60	36	32	28,5	9041109
9041110	1/2"	SW19	60	36	32	30,4	9041110
9041052	1/2"	SW21	60	60	34	34	9041052

Nástrčná hlavice 6-ti hranná L60, Pinch-point 6-point socket L60, Pinch-point



Kód	Pohon	Výstup	L	L1	D1	D	Náhr. pouzdra
Code	Input	Output	L	L1	D1	D	Repl. Sleeves
9041099-pp	1/2"	SW8	60	32	27,5	16,8	9051099-pp
9041100-pp	1/2"	SW9	60	32	27,5	17,9	9051100-pp
9041101-pp	1/2"	SW10	60	34	27,5	19,3	9051101-pp
9041102-pp	1/2"	SW11	60	34	27,5	20,5	9051102-pp
9041103-pp	1/2"	SW12	60	34	27,5	21,8	9051103-pp
9041104-pp	1/2"	SW13	60	35	27,5	23	9051104-pp
9041105-pp	1/2"	SW14	60	36	27,5	24,3	9051105-pp
9041106-pp	1/2"	SW15	60	32	32	24,8	9051106-pp
9041107-pp	1/2"	SW16	60	34	32	26	9051107-pp
9041108-pp	1/2"	SW17	60	35	32	27	9051108-pp
9041109-pp	1/2"	SW18	60	36	32	28,5	9041109-pp
9041110-pp	1/2"	SW19	60	36	32	30,4	9041110-pp
9041052-pp	1/2"	SW21	60	60	34	34	9041052-pp

Nástrčná hlavice 6-ti hranná L65 6-point socket L65



Kód	Pohon	Výstup	L	L1	D1	D	Náhr. pouzdra
Code	Input	Output	L	L1	D1	D	Repl. Sleeves
9041112	1/2"	SW22	65	42	34	33	9051112
9041053	1/2"	SW24	65	42	35	33	9051053
9041114	1/2"	SW27	65	42	36	33	9051114
9041115	1/2"	SW30	65	42	36	33	9051115
9041116	1/2"	SW32	65	42	40	33	9051116

Nástrčná hlavice 6-ti hranná L65, Pinch-point 6-point socket L65, Pinch-point



Kód	Pohon	Výstup	L	L1	D1	D	Náhr. pouzdra
Code	Input	Output	L	L1	D1	D	Repl. Sleeves
9041112-pp	1/2"	SW22	65	42	34	33	9051112-pp
9041053-pp	1/2"	SW24	65	42	35	33	9051053-pp
9041114-pp	1/2"	SW27	65	42	36	33	9051114-pp
9041115-pp	1/2"	SW30	65	42	36	33	9051115-pp
9041116-pp	1/2"	SW32	65	42	40	33	9051116-pp

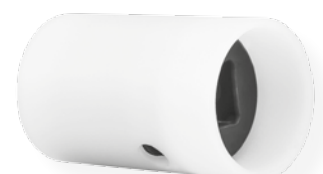
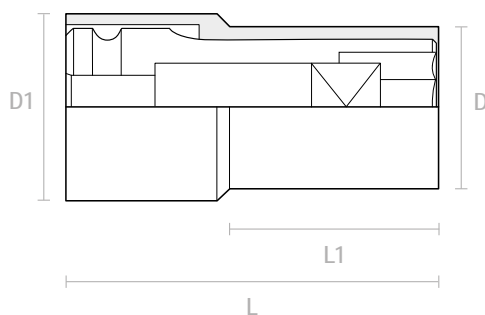

Pinch-point

Nástrčná hlavice 6-ti hranná s tyčovým magnetem L60
6-point socket with central magnet L60



Kód	Pohon	Výstup	L	L1	D1	D	Náhr. pouzdra
Code	Input	Output	L	L1	D1	D	Repl. Sleeves
9041099-1	1/2"	SW8	60	32	27,5	16,8	9051099-1
9041100-1	1/2"	SW9	60	32	27,5	17,9	9051100-1
9041101-1	1/2"	SW10	60	34	27,5	19,3	9051101-1
9041102-1	1/2"	SW11	60	34	27,5	20,5	9051102-1
9041103-1	1/2"	SW12	60	34	27,5	21,8	9051103-1
9041104-1	1/2"	SW13	60	35	27,5	23	9051104-1
9041105-1	1/2"	SW14	60	36	27,5	24,3	9051105-1
9041106-1	1/2"	SW15	60	32	32	24,8	9051106-1
9041107-1	1/2"	SW16	60	34	32	26	9051017-1
9041108-1	1/2"	SW17	60	35	32	27	9051108-1
9041109-1	1/2"	SW18	60	36	32	28,5	9051109-1
9041110-1	1/2"	SW19	60	36	32	30,4	9051110-1
9041052-1	1/2"	SW21	60	60	34	34	9051052-1

Nástrčná hlavice 6-ti hranná s tyčovým magnetem L60, Pinch-p.
6-point socket with central magnet L60, Pinch-point



Kód	Pohon	Výstup	L	L1	D1	D	Náhr. pouzdra
Code	Input	Output	L	L1	D1	D	Repl. Sleeves
9041099-1-pp	1/2"	SW8	60	32	27,5	16,8	9051099-1-pp
9041100-1-pp	1/2"	SW9	60	32	27,5	17,9	9051100-1-pp
9041101-1-pp	1/2"	SW10	60	34	27,5	19,3	9051101-1-pp
9041102-1-pp	1/2"	SW11	60	34	27,5	20,5	9051102-1-pp
9041103-1-pp	1/2"	SW12	60	34	27,5	21,8	9051103-1-pp
9041104-1-pp	1/2"	SW13	60	35	27,5	23	9051104-1-pp
9041105-1-pp	1/2"	SW14	60	36	27,5	24,3	9051105-1-pp
9041106-1-pp	1/2"	SW15	60	32	32	24,8	9051106-1-pp
9041107-1-pp	1/2"	SW16	60	34	32	26	9051017-1-pp
9041108-1-pp	1/2"	SW17	60	35	32	27	9051108-1-pp
9041109-1-pp	1/2"	SW18	60	36	32	28,5	9051109-1-pp
9041110-1-pp	1/2"	SW19	60	36	32	30,4	9051110-1-pp
9041052-1-pp	1/2"	SW21	60	60	34	34	9051052-1-pp

covertec nářadí

covertec tools

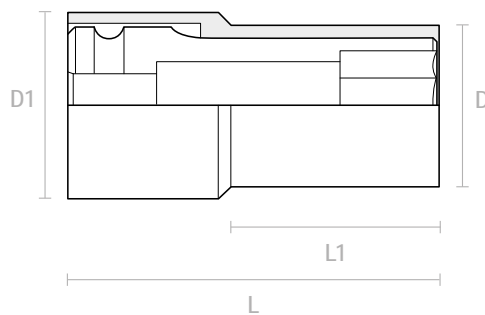

Pinch-point

Nástrčná hlavice 6-ti hranná 3 bodový magnet L60 6-point socket 3-point magnet L60



Kód	Pohon	Výstup	L	L1	D1	D	Náhr. pouzdra
Code	Input	Output	L	L1	D1	D	Repl. Sleeves
9041099-2	1/2"	SW8	60	32	27,5	16,8	9051099-2
9041100-2	1/2"	SW9	60	32	27,5	17,9	9051100-2
9041101-2	1/2"	SW10	60	34	27,5	19,3	9051101-2
9041102-2	1/2"	SW11	60	34	27,5	20,5	9051102-2
9041103-2	1/2"	SW12	60	34	27,5	21,8	9051103-2
9041104-2	1/2"	SW13	60	35	27,5	23	9051104-2
9041105-2	1/2"	SW14	60	36	27,5	24,3	9051105-2
9041106-2	1/2"	SW15	60	32	32	24,8	9051106-2
9041107-2	1/2"	SW16	60	34	32	26	9051107-2
9041108-2	1/2"	SW17	60	35	32	27	9041108-2
9041109-2	1/2"	SW18	60	36	32	28,5	9051109-2
9041110-2	1/2"	SW19	60	36	32	30,4	9051110-2
9041052-2	1/2"	SW21	60	60	34	34	9051052-2

Nástrčná hlavice Surface-drive L60 Socket surface-drive L60



Kód	Pohon	Výstup	L	L1	D1	D	Náhr. pouzdra
Code	Input	Output	L	L1	D1	D	Repl. Sleeves
9041099-4	1/2"	SW8sd	60	32	27,5	16,8	9051099-4
9041100-4	1/2"	SW9sd	60	32	27,5	17,9	9051100-4
9041101-4	1/2"	SW10sd	60	34	27,5	19,3	9051101-4
9041102-4	1/2"	SW11sd	60	34	27,5	20,5	9051102-4
9041103-4	1/2"	SW12sd	60	34	27,5	21,8	9051103-4
9041104-4	1/2"	SW13sd	60	35	27,5	23	9051104-4
9041105-4	1/2"	SW14sd	60	36	27,5	24,3	9051105-4
9041106-4	1/2"	SW15sd	60	32	32	24,8	9051106-4
9041107-4	1/2"	SW16sd	60	34	32	26	9051107-4
9041108-4	1/2"	SW17sd	60	35	32	27	9051108-4
9041109-4	1/2"	SW18sd	60	36	32	28,5	9051109-4
9041110-4	1/2"	SW19sd	60	36	32	30,4	9051110-4
9041052-4	1/2"	SW21sd	60	60	34	34	9051052-4

Nástrčná hlavice 6-ti hranná 3 bodový magnet L60, Pinch-point 6-point socket 3-point magnet L60, Pinch-point



Kód	Pohon	Výstup	L	L1	D1	D	Náhr. pouzdra
Code	Input	Output	L	L1	D1	D	Repl. Sleeves
9041099-2-pp	1/2"	SW8	60	32	27,5	16,8	9051099-2-pp
9041100-2-pp	1/2"	SW9	60	32	27,5	17,9	9051100-2-pp
9041101-2-pp	1/2"	SW10	60	34	27,5	19,3	9051101-2-pp
9041102-2-pp	1/2"	SW11	60	34	27,5	20,5	9051102-2-pp
9041103-2-pp	1/2"	SW12	60	34	27,5	21,8	9051103-2-pp
9041104-2-pp	1/2"	SW13	60	35	27,5	23	9051104-2-pp
9041105-2-pp	1/2"	SW14	60	36	27,5	24,3	9051105-2-pp
9041106-2-pp	1/2"	SW15	60	32	32	24,8	9051106-2-pp
9041107-2-pp	1/2"	SW16	60	34	32	26	9051107-2-pp
9041108-2-pp	1/2"	SW17	60	35	32	27	9041108-2-pp
9041109-2-pp	1/2"	SW18	60	36	32	28,5	9051109-2-pp
9041110-2-pp	1/2"	SW19	60	36	32	30,4	9051110-2-pp
9041052-2-pp	1/2"	SW21	60	60	34	34	9051052-2-pp

Nástrčná hlavice Surface-drive L60, Pinch-point Socket surface-drive L60, Pinch-point



Kód	Pohon	Výstup	L	L1	D1	D	Náhr. pouzdra
Code	Input	Output	L	L1	D1	D	Repl. Sleeves
9041099-4-pp	1/2"	SW8sd	60	32	27,5	16,8	9051099-4-pp
9041100-4-pp	1/2"	SW9sd	60	32	27,5	17,9	9051100-4-pp
9041101-4-pp	1/2"	SW10sd	60	34	27,5	19,3	9051101-4-pp
9041102-4-pp	1/2"	SW11sd	60	34	27,5	20,5	9051102-4-pp
9041103-4-pp	1/2"	SW12sd	60	34	27,5	21,8	9051103-4-pp
9041104-4-pp	1/2"	SW13sd	60	35	27,5	23	9051104-4-pp
9041105-4-pp	1/2"	SW14sd	60	36	27,5	24,3	9051105-4-pp
9041106-4-pp	1/2"	SW15sd	60	32	32	24,8	9051106-4-pp
9041107-4-pp	1/2"	SW16sd	60	34	32	26	9051107-4-pp
9041108-4-pp	1/2"	SW17sd	60	35	32	27	9051108-4-pp
9041109-4-pp	1/2"	SW18sd	60	36	32	28,5	9051109-4-pp
9041110-4-pp	1/2"	SW19sd	60	36	32	30,4	9051110-4-pp
9041052-4-pp	1/2"	SW21sd	60	60	34	34	9051052-4-pp

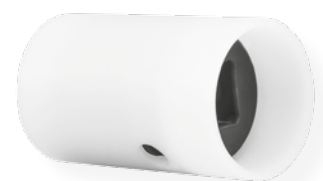
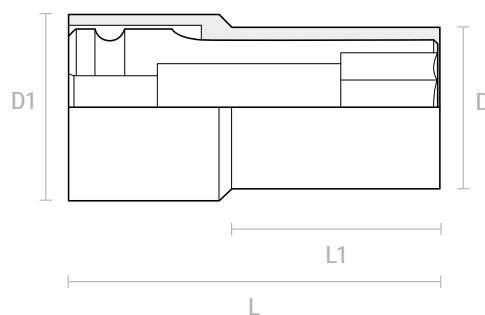

Pinch-point

Nástrčná hlavice dvojité 6-ti hran L60/65
12-point socket L60/65



Kód	Pohon	Výstup	L	L1	D1	D	Náhr. pouzdra
Code	Input	Output	L	L1	D1	D	Repl. Sleeves
9041099-5	1/2"	SW8	60	32	27,5	16,8	9051099-5
9041100-5	1/2"	SW9	60	32	27,5	17,9	9051100-5
9041101-5	1/2"	SW10	60	34	27,5	19,3	9051101-5
9041102-5	1/2"	SW11	60	34	27,5	20,5	9051102-5
9041103-5	1/2"	SW12	60	34	27,5	21,8	9051103-5
9041104-5	1/2"	SW13	60	35	27,5	23	9051104-5
9041105-5	1/2"	SW14	60	36	27,5	24,3	9051105-5
9041106-5	1/2"	SW15	60	32	32	24,8	9051106-5
9041107-5	1/2"	SW16	60	34	32	26	9051017-5
9041108-5	1/2"	SW17	60	35	32	27	9051108-5
9041109-5	1/2"	SW18	60	36	32	28,5	9051109-5
9041110-5	1/2"	SW19	60	36	32	30,4	9051110-5
9041052-5	1/2"	SW21	60	60	34	34	9051052-5
9041112-5	1/2"	SW22	65	42	34	33	9051112-5
9041053-5	1/2"	SW24	65	42	35	33	9051053-5
9041114-5	1/2"	SW27	65	42	36	33	9051114-5
9041115-5	1/2"	SW30	65	42	36	33	9051115-5
9041116-5	1/2"	SW32	65	42	40	33	9051116-5

Nástrčná hlavice dvojité 6-ti hran L60/65, Pinch-point
12-point socket L60/65, Pinch-point



Kód	Pohon	Výstup	L	L1	D1	D	Náhr. pouzdra
Code	Input	Output	L	L1	D1	D	Repl. Sleeves
9041099-5-pp	1/2"	SW8	60	32	27,5	16,8	9051099-5-pp
9041100-5-pp	1/2"	SW9	60	32	27,5	17,9	9051100-5-pp
9041101-5-pp	1/2"	SW10	60	34	27,5	19,3	9051101-5-pp
9041102-5-pp	1/2"	SW11	60	34	27,5	20,5	9051102-5-pp
9041103-5-pp	1/2"	SW12	60	34	27,5	21,8	9051103-5-pp
9041104-5-pp	1/2"	SW13	60	35	27,5	23	9051104-5-pp
9041105-5-pp	1/2"	SW14	60	36	27,5	24,3	9051105-5-pp
9041106-5-pp	1/2"	SW15	60	32	32	24,8	9051106-5-pp
9041107-5-pp	1/2"	SW16	60	34	32	26	9051017-5-pp
9041108-5-pp	1/2"	SW17	60	35	32	27	9051108-5-pp
9041109-5-pp	1/2"	SW18	60	36	32	28,5	9051109-5-pp
9041110-5-pp	1/2"	SW19	60	36	32	30,4	9051110-5-pp
9041052-5-pp	1/2"	SW21	60	60	34	34	9051052-5-pp
9041112-5-pp	1/2"	SW22	65	42	34	33	9051112-5-pp
9041053-5-pp	1/2"	SW24	65	42	35	33	9051053-5-pp
9041114-5-pp	1/2"	SW27	65	42	36	33	9051114-5-pp
9041115-5-pp	1/2"	SW30	65	42	36	33	9051115-5-pp
9041116-5-pp	1/2"	SW32	65	42	40	33	9051116-5-pp

covertec 1/2"

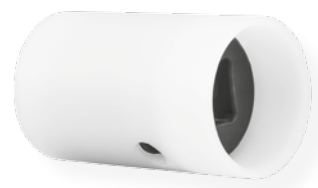
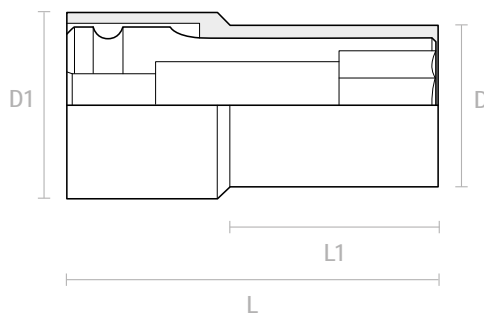

Pinch-point

Nástrčná hlavice 6-ti hranná L80/85 6-point socket L80/L85



Kód	Pohon	Výstup	L	L1	D1	D	Náhradní pouzdra
Code	In-/	Output	L	L1	D1	D	Repl. Sleeves
9041099	1/2"	SW8	80	32	27,5	16,8	9051099
9041117	1/2"	SW8	80	45	29	18,5	9051117
9041118	1/2"	SW9	80	45	29	20	9051118
9041119	1/2"	SW10	80	45	29	21	9051119
9041120	1/2"	SW11	80	47	29	22	9051120
9041121	1/2"	SW12	80	47	29	23	9051121
9041122	1/2"	SW13	80	48	28	23,5	9051122
9041123	1/2"	SW14	80	48	32	25,5	9051123
9041055	1/2"	SW15	80	49	32	26,5	9051055
9041125	1/2"	SW16	80	47	33	28	9051125
9041043	1/2"	SW17	80	49	33	29	9051043
9041126	1/2"	SW18	80	52	33	30	9051126
9041127	1/2"	SW19	80	52	33	31	9051127
9041128	1/2"	SW21	80	80	34	34	9051128
9041129	1/2"	SW22	85	58	33	34	9051129
9041130	1/2"	SW24	85	58	33	36	9051130
9041131	1/2"	SW27	85	57	33	41	9051131
9041132	1/2"	SW30	85	56	33	44	9051132
9041133	1/2"	SW32	85	56	33	47	9051133

Nástrčná hlavice 6-ti hranná L80/85, Pinch-point 6-point socket L80/L85, Pinch-point



Kód	Pohon	Výstup	L	L1	D1	D	Náhradní pouzdra
Code	In-/	Output	L	L1	D1	D	Repl. Sleeves
9041099-pp	1/2"	SW8	80	32	27,5	16,8	9051099-pp
9041117-pp	1/2"	SW8	80	45	29	18,5	9051117-pp
9041118-pp	1/2"	SW9	80	45	29	20	9051118-pp
9041119-pp	1/2"	SW10	80	45	29	21	9051119-pp
9041120-pp	1/2"	SW11	80	47	29	22	9051120-pp
9041121-pp	1/2"	SW12	80	47	29	23	9051121-pp
9041122-pp	1/2"	SW13	80	48	28	23,5	9051122-pp
9041123-pp	1/2"	SW14	80	48	32	25,5	9051123-pp
9041055-pp	1/2"	SW15	80	49	32	26,5	9051055-pp
9041125-pp	1/2"	SW16	80	47	33	28	9051125-pp
9041043-pp	1/2"	SW17	80	49	33	29	9051043-pp
9041126-pp	1/2"	SW18	80	52	33	30	9051126-pp
9041127-pp	1/2"	SW19	80	52	33	31	9051127-pp
9041128-pp	1/2"	SW21	80	80	34	34	9051128-pp
9041129-pp	1/2"	SW22	85	58	33	34	9051129-pp
9041130-pp	1/2"	SW24	85	58	33	36	9051130-pp
9041131-pp	1/2"	SW27	85	57	33	41	9051131-pp
9041132-pp	1/2"	SW30	85	56	33	44	9051132-pp
9041133-pp	1/2"	SW32	85	56	33	47	9051133-pp

Nástrčná hlavice L80/85, Torx Socket L80/L85, Torx



Kód	Pohon	Výstup	L	L1	D1	D	Náhradní pouzdra
Code	In-/	Output	L	L1	D1	D	Repl. Sleeves
9041193	1/2"	E10	80	46	29	17,5	9051193
9041194	1/2"	E12	80	45	29	18,5	9051194
9041195	1/2"	E14	80	48	29	22,55	9051195
9041196	1/2"	E16	80	48	29	24	9051196
9041197	1/2"	E18	80	50	29	26	9051197
9041198	1/2"	E20	80	80	29	29	9051198

Nástrčná hlavice L80/85, Pinch-point, Torx Socket L80/L85, Pinch-point, Torx



Kód	Pohon	Výstup	L	L1	D1	D	Náhradní pouzdra
Code	In-/	Output	L	L1	D1	D	Repl. Sleeves
9041193-pp	1/2"	E10	80	46	29	17,5	9051193-pp
9041194-pp	1/2"	E12	80	45	29	18,5	9051194-pp
9041195-pp	1/2"	E14	80	48	29	22,55	9051195-pp
9041196-pp	1/2"	E16	80	48	29	24	9051196-pp
9041197-pp	1/2"	E18	80	50	29	26	9051197-pp
9041198-pp	1/2"	E20	80	80	29	29	9051198-pp

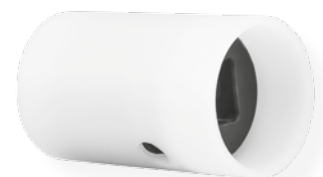
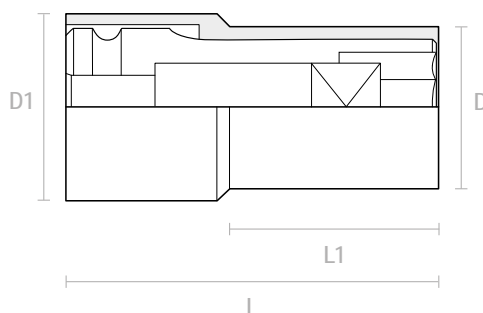

Pinch-point

Nástrčná hlavice 6-ti hranná s tyčovým magnetem L80/85
6-point socket with central magnet L80/85



Kód	Pohon	Výstup	L	L1	D1	D	Náhradní pouzdra
Code	In-/	Output	L	L1	D1	D	Repl. Sleeves
9041117-1	1/2"	SW8	80	45	29	18,5	9051117-1
9041118-1	1/2"	SW9	80	45	29	20	9051118-1
9041119-1	1/2"	SW10	80	45	29	21	9051119-1
9041120-1	1/2"	SW11	80	47	29	22	9051120-1
9041121-1	1/2"	SW12	80	47	29	23	9051121-1
9041122-1	1/2"	SW13	80	48	28	23,5	9051122-1
9041123-1	1/2"	SW14	80	48	32	25,5	9051123-1
9041055-1	1/2"	SW15	80	49	32	26,5	9051055-1
9041125-1	1/2"	SW16	80	47	33	28	9051125-1
9041043-1	1/2"	SW17	80	49	33	29	9051043-1
9041126-1	1/2"	SW18	80	52	33	30	9051126-1
9041127-1	1/2"	SW19	80	52	33	31	9051127-1
9041128-1	1/2"	SW21	80	80	34	34	9051128-1
9041129-1	1/2"	SW22	85	58	33	34	9051129-1
9041130-1	1/2"	SW24	85	58	33	36	9051130-1
9041131-1	1/2"	SW27	85	57	33	41	9051131-1
9041132-1	1/2"	SW30	85	56	33	44	9051132-1
9041133-1	1/2"	SW32	85	56	33	47	9051133-1

Nástrčná hlavice 6-ti hranná s tyčovým magnetem L80/85, Pinch-p.
6-point socket with central magnet L80/85, Pinch-point



Kód	Pohon	Výstup	L	L1	D1	D	Náhradní pouzdra
Code	In-/	Output	L	L1	D1	D	Repl. Sleeves
9041117-1-pp	1/2"	SW8	80	45	29	18,5	9051117-1-pp
9041118-1-pp	1/2"	SW9	80	45	29	20	9051118-1-pp
9041119-1-pp	1/2"	SW10	80	45	29	21	9051119-1-pp
9041120-1-pp	1/2"	SW11	80	47	29	22	9051120-1-pp
9041121-1-pp	1/2"	SW12	80	47	29	23	9051121-1-pp
9041122-1-pp	1/2"	SW13	80	48	28	23,5	9051122-1-pp
9041123-1-pp	1/2"	SW14	80	48	32	25,5	9051123-1-pp
9041055-1-pp	1/2"	SW15	80	49	32	26,5	9051055-1-pp
9041125-1-pp	1/2"	SW16	80	47	33	28	9051125-1-pp
9041043-1-pp	1/2"	SW17	80	49	33	29	9051043-1-pp
9041126-1-pp	1/2"	SW18	80	52	33	30	9051126-1-pp
9041127-1-pp	1/2"	SW19	80	52	33	31	9051127-1-pp
9041128-1-pp	1/2"	SW21	80	80	34	34	9051128-1-pp
9041129-1-pp	1/2"	SW22	85	58	33	34	9051129-1-pp
9041130-1-pp	1/2"	SW24	85	58	33	36	9051130-1-pp
9041131-1-pp	1/2"	SW27	85	57	33	41	9051131-1-pp
9041132-1-pp	1/2"	SW30	85	56	33	44	9051132-1-pp
9041133-1-pp	1/2"	SW32	85	56	33	47	9051133-1-pp

Nástrčná hlavice s tyčovým magnetem L80/85, Torx
Socket with central magnet L80/85, Torx



Kód	Pohon	Výstup	L	L1	D1	D	Náhradní pouzdra
Code	In-/	Output	L	L1	D1	D	Repl. Sleeves
9041193-1	1/2"	E10	80	46	29	17,5	9051193-1
9041194-1	1/2"	E12	80	45	29	18,5	9051194-1
9041195-1	1/2"	E14	80	48	29	22,55	9051195-1
9041196-1	1/2"	E16	80	48	29	24	9051196-1
9041197-1	1/2"	E18	80	50	29	26	9051197-1
9041198-1	1/2"	E20	80	80	29	29	9051198-1

Nástrčná hlavice s tyčovým magnetem L80/85, Pinch-point, Torx
Socket with central magnet L80/85, Pinch-point, Torx



Kód	Pohon	Výstup	L	L1	D1	D	Náhradní pouzdra
Code	In-/	Output	L	L1	D1	D	Repl. Sleeves
9041193-1-pp	1/2"	E10	80	46	29	17,5	9051193-1-pp
9041194-1-pp	1/2"	E12	80	45	29	18,5	9051194-1-pp
9041195-1-pp	1/2"	E14	80	48	29	22,55	9051195-1-pp
9041196-1-pp	1/2"	E16	80	48	29	24	9051196-1-pp
9041197-1-pp	1/2"	E18	80	50	29	26	9051197-1-pp
9041198-1-pp	1/2"	E20	80	80	29	29	9051198-1-pp

covertec nářadí

covertec tools

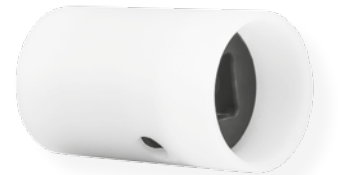
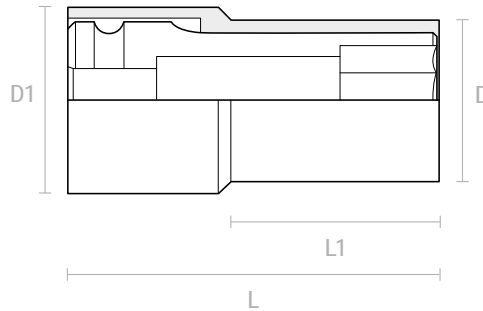

Pinch-point

covertec 1/2"

Nástrčná hlavice 6-ti hranná 3 bodový magnet L80/85 6-point socket 3-point magnet L80/85



Kód	Pohon	Výstup	L	L1	D1	D	Náhradní pouzdra
Code	In-/	Output	L	L1	D1	D	Repl. Sleeves
9041117-2	1/2"	SW8	80	45	29	18,5	9051117-2
9041118-2	1/2"	SW9	80	45	29	20	9051118-2
9041119-2	1/2"	SW10	80	45	29	21	9051119-2
9041120-2	1/2"	SW11	80	47	29	22	9051120-2
9041121-2	1/2"	SW12	80	47	29	23	9051121-2
9041122-2	1/2"	SW13	80	48	28	23,5	9051122-2
9041123-2	1/2"	SW14	80	48	32	25,5	9051123-2
9041055-2	1/2"	SW15	80	49	32	26,5	9051055-2
9041125-2	1/2"	SW16	80	47	33	28	9051125-2
9041043-2	1/2"	SW17	80	49	33	29	9051043-2
9041126-2	1/2"	SW18	80	52	33	30	9051126-2
9041127-2	1/2"	SW19	80	52	33	31	9051127-2
9041128-2	1/2"	SW21	80	80	34	34	9051128-2
9041129-2	1/2"	SW22	85	58	33	34	9051129-2
9041130-2	1/2"	SW24	85	58	33	36	9051130-2
9041131-2	1/2"	SW27	85	57	33	41	9051131-2
9041132-2	1/2"	SW30	85	56	33	44	9051132-2
9041133-2	1/2"	SW32	85	56	33	47	9051133-2

Nástrčná hlavice 6-ti hranná 3 bodový magnet L80/85, Pinch-p. 6-point socket 3-point magnet L80/85, Pinch-point



Kód	Pohon	Výstup	L	L1	D1	D	Náhradní pouzdra
Code	In-/	Output	L	L1	D1	D	Repl. Sleeves
9041117-2-pp	1/2"	SW8	80	45	29	18,5	9051117-2-pp
9041118-2-pp	1/2"	SW9	80	45	29	20	9051118-2-pp
9041119-2-pp	1/2"	SW10	80	45	29	21	9051119-2-pp
9041120-2-pp	1/2"	SW11	80	47	29	22	9051120-2-pp
9041121-2-pp	1/2"	SW12	80	47	29	23	9051121-2-pp
9041122-2-pp	1/2"	SW13	80	48	28	23,5	9051122-2-pp
9041123-2-pp	1/2"	SW14	80	48	32	25,5	9051123-2-pp
9041055-2-pp	1/2"	SW15	80	49	32	26,5	9051055-2-pp
9041125-2-pp	1/2"	SW16	80	47	33	28	9051125-2-pp
9041043-2-pp	1/2"	SW17	80	49	33	29	9051043-2-pp
9041126-2-pp	1/2"	SW18	80	52	33	30	9051126-2-pp
9041127-2-pp	1/2"	SW19	80	52	33	31	9051127-2-pp
9041128-2-pp	1/2"	SW21	80	80	34	34	9051128-2-pp
9041129-2-pp	1/2"	SW22	85	58	33	34	9051129-2-pp
9041130-2-pp	1/2"	SW24	85	58	33	36	9051130-2-pp
9041131-2-pp	1/2"	SW27	85	57	33	41	9051131-2-pp
9041132-2-pp	1/2"	SW30	85	56	33	44	9051132-2-pp
9041133-2-pp	1/2"	SW32	85	56	33	47	9051133-2-pp

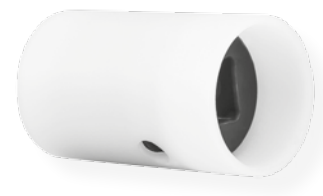
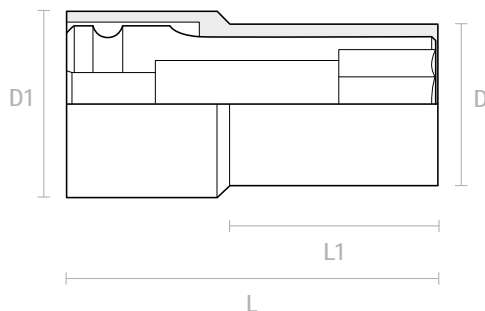

Pinch-point

Nástrčná hlavice Surface-drive L80/85
Socket surface-drive L80/85



Kód	Pohon	Výstup	L	L1	D1	D	Náhradní pouzdra
Code	In-/	Output	L	L1	D1	D	Repl. Sleeves
9041117-4	1/2"	SW8sd	80	45	29	18,5	9051117-4
9041118-4	1/2"	SW9sd	80	45	29	20	9051118-4
9041119-4	1/2"	SW10sd	80	45	29	21	9051119-4
9041120-4	1/2"	SW11sd	80	47	29	22	9051120-4
9041121-4	1/2"	SW12sd	80	47	29	23	9051121-4
9041122-4	1/2"	SW13sd	80	48	28	23,5	9051122-4
9041123-4	1/2"	SW14sd	80	48	32	25,5	9051123-4
9041055-4	1/2"	SW15sd	80	49	32	26,5	9051055-4
9041125-4	1/2"	SW16sd	80	47	33	28	9051125-4
9041043-4	1/2"	SW17sd	80	49	33	29	9051043-4
9041126-4	1/2"	SW18sd	80	52	33	30	9051126-4
9041127-4	1/2"	SW19sd	80	52	33	31	9051127-4
9041128-4	1/2"	SW21sd	80	80	34	34	9051128-4
9041129-4	1/2"	SW22sd	85	58	33	34	9051129-4
9041130-4	1/2"	SW24sd	85	58	33	36	9051130-4
9041131-4	1/2"	SW27sd	85	57	33	41	9051131-4
9041132-4	1/2"	SW30sd	85	56	33	44	9051132-4
9041133-4	1/2"	SW32sd	85	56	33	47	9051133-4

Nástrčná hlavice Surface-drive L80/85, Pinch-point
Socket surface-drive L80/85, Pinch-point



Kód	Pohon	Výstup	L	L1	D1	D	Náhradní pouzdra
Code	In-/	Output	L	L1	D1	D	Repl. Sleeves
9041117-4-pp	1/2"	SW8sd	80	45	29	18,5	9051117-4-pp
9041118-4-pp	1/2"	SW9sd	80	45	29	20	9051118-4-pp
9041119-4-pp	1/2"	SW10sd	80	45	29	21	9051119-4-pp
9041120-4-pp	1/2"	SW11sd	80	47	29	22	9051120-4-pp
9041121-4-pp	1/2"	SW12sd	80	47	29	23	9051121-4-pp
9041122-4-pp	1/2"	SW13sd	80	48	28	23,5	9051122-4-pp
9041123-4-pp	1/2"	SW14sd	80	48	32	25,5	9051123-4-pp
9041055-4-pp	1/2"	SW15sd	80	49	32	26,5	9051055-4-pp
9041125-4-pp	1/2"	SW16sd	80	47	33	28	9051125-4-pp
9041043-4-pp	1/2"	SW17sd	80	49	33	29	9051043-4-pp
9041126-4-pp	1/2"	SW18sd	80	52	33	30	9051126-4-pp
9041127-4-pp	1/2"	SW19sd	80	52	33	31	9051127-4-pp
9041128-4-pp	1/2"	SW21sd	80	80	34	34	9051128-4-pp
9041129-4-pp	1/2"	SW22sd	85	58	33	34	9051129-4-pp
9041130-4-pp	1/2"	SW24sd	85	58	33	36	9051130-4-pp
9041131-4-pp	1/2"	SW27sd	85	57	33	41	9051131-4-pp
9041132-4-pp	1/2"	SW30sd	85	56	33	44	9051132-4-pp
9041133-4-pp	1/2"	SW32sd	85	56	33	47	9051133-4-pp

covertec nářadí

covertec tools

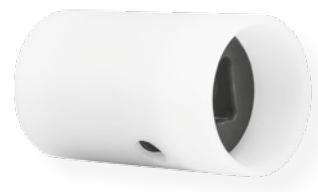
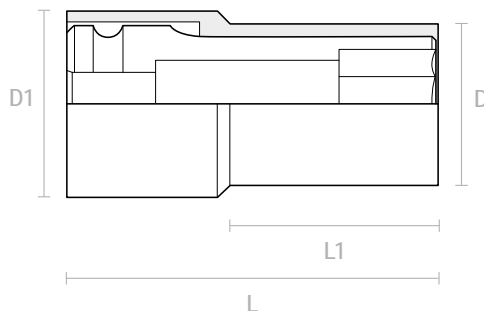

Pinch-point

covertec 1/2"

Nástrčná hlavice dvojitý 6-ti hran L80/85 12-point socket L80/85



Kód	Pohon	Výstup	L	L1	D1	D	Náhradní pouzdra
Code	In-/	Output	L	L1	D1	D	Repl. Sleeves
9041117-5	1/2"	SW8	80	45	29	18,5	9051117-5
9041118-5	1/2"	SW9	80	45	29	20	9051118-5
9041119-5	1/2"	SW10	80	45	29	21	9051119-5
9041120-5	1/2"	SW11	80	47	29	22	9051120-5
9041121-5	1/2"	SW12	80	47	29	23	9051121-5
9041122-5	1/2"	SW13	80	48	28	23,5	9051122-5
9041123-5	1/2"	SW14	80	48	32	25,5	9051123-5
9041055-5	1/2"	SW15	80	49	32	26,5	9051055-5
9041125-5	1/2"	SW16	80	47	33	28	9051125-5
9041043-5	1/2"	SW17	80	49	33	29	9051043-5
9041126-5	1/2"	SW18	80	52	33	30	9051126-5
9041127-5	1/2"	SW19	80	52	33	31	9051127-5
9041128-5	1/2"	SW21	80	80	34	34	9051128-5
9041129-5	1/2"	SW22	85	58	33	34	9051129-5
9041130-5	1/2"	SW24	85	58	33	36	9051130-5
9041131-5	1/2"	SW27	85	57	33	41	9051131-5
9041132-5	1/2"	SW30	85	56	33	44	9051132-5
9041133-5	1/2"	SW32	85	56	33	47	9051133-5

Nástrčná hlavice dvojitý 6-ti hran L80/85, Pinch-point 12-point socket L80/85, Pinch-point



Kód	Pohon	Výstup	L	L1	D1	D	Náhradní pouzdra
Code	In-/	Output	L	L1	D1	D	Repl. Sleeves
9041117-5-pp	1/2"	SW8	80	45	29	18,5	9051117-5-pp
9041118-5-pp	1/2"	SW9	80	45	29	20	9051118-5-pp
9041119-5-pp	1/2"	SW10	80	45	29	21	9051119-5-pp
9041120-5-pp	1/2"	SW11	80	47	29	22	9051120-5-pp
9041121-5-pp	1/2"	SW12	80	47	29	23	9051121-5-pp
9041122-5-pp	1/2"	SW13	80	48	28	23,5	9051122-5-pp
9041123-5-pp	1/2"	SW14	80	48	32	25,5	9051123-5-pp
9041055-5-pp	1/2"	SW15	80	49	32	26,5	9051055-5-pp
9041125-5-pp	1/2"	SW16	80	47	33	28	9051125-5-pp
9041043-5-pp	1/2"	SW17	80	49	33	29	9051043-5-pp
9041126-5-pp	1/2"	SW18	80	52	33	30	9051126-5-pp
9041127-5-pp	1/2"	SW19	80	52	33	31	9051127-5-pp
9041128-5-pp	1/2"	SW21	80	80	34	34	9051128-5-pp
9041129-5-pp	1/2"	SW22	85	58	33	34	9051129-5-pp
9041130-5-pp	1/2"	SW24	85	58	33	36	9051130-5-pp
9041131-5-pp	1/2"	SW27	85	57	33	41	9051131-5-pp
9041132-5-pp	1/2"	SW30	85	56	33	44	9051132-5-pp
9041133-5-pp	1/2"	SW32	85	56	33	47	9051133-5-pp

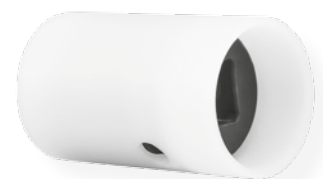
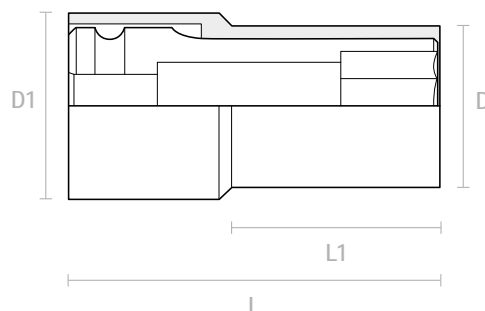

Pinch-point

Nástrčná hlavice 6-ti hranná tenkostěnná
6-point socket thin walled



Kód	Pohon	Výstup	L	L1	D1	D	Náhr. pouzdra
Code	In-/	Output	L	L1	D1	D	Repl. Sleeves
9041210-77-10	1/2"	SW10	77	48	24	18,5	9051210-77-10
9041211-77-10	1/2"	SW11	77	48	24	19,5	9051211-77-10
9041212-77-10	1/2"	SW12	77	48	24	21	9051212-77-10
9041213-77-10	1/2"	SW13	77	48	25	22	9051213-77-10
9041214-77-10	1/2"	SW14	77	48	25	23,5	9051214-77-10
9041215-77-10	1/2"	SW15	77	48	25	24,5	9051215-77-10
9041216-77-10	1/2"	SW16	77	77	26	26	9051216-77-10
9041217-77-10	1/2"	SW17	77	77	27	27	9051217-77-10
9041218-77-10	1/2"	SW18	77	77	28	28	9051218-77-10
9041219-77-10	1/2"	SW19	77	77	30	30	9051219-77-10
9041220-77-10	1/2"	SW20	77	77	31	31	9051220-77-10
9041221-77-10	1/2"	SW21	77	77	32	32	9051221-77-10
9041222-77-10	1/2"	SW22	77	77	33	33	9051222-77-10
9041224-77-10	1/2"	SW24	77	77	36	36	9051224-77-10
9041227-77-10	1/2"	SW27	77	77	40	40	9051227-77-10
9041230-77-10	1/2"	SW30	77	77	43,5	43,5	9051230-77-10
9041232-77-10	1/2"	SW32	77	77	46,5	46,5	9051232-77-10

Nástrčná hlavice 6-ti hranná tenkostěnná, Pinch-point
6-point socket thin walled, Pinch-point



Kód	Pohon	Výstup	L	L1	D1	D	Náhr. pouzdra
Code	In-/	Output	L	L1	D1	D	Repl. Sleeves
9041210-77-10-pp	1/2"	SW10	77	48	24	18,5	9051210-77-10-pp
9041211-77-10-pp	1/2"	SW11	77	48	24	19,5	9051211-77-10-pp
9041212-77-10-pp	1/2"	SW12	77	48	24	21	9051212-77-10-pp
9041213-77-10-pp	1/2"	SW13	77	48	25	22	9051213-77-10-pp
9041214-77-10-pp	1/2"	SW14	77	48	25	23,5	9051214-77-10-pp
9041215-77-10-pp	1/2"	SW15	77	48	25	24,5	9051215-77-10-pp
9041216-77-10-pp	1/2"	SW16	77	77	26	26	9051216-77-10-pp
9041217-77-10-pp	1/2"	SW17	77	77	27	27	9051217-77-10-pp
9041218-77-10-pp	1/2"	SW18	77	77	28	28	9051218-77-10-pp
9041219-77-10-pp	1/2"	SW19	77	77	30	30	9051219-77-10-pp
9041220-77-10-pp	1/2"	SW20	77	77	31	31	9051220-77-10-pp
9041221-77-10-pp	1/2"	SW21	77	77	32	32	9051221-77-10-pp
9041222-77-10-pp	1/2"	SW22	77	77	33	33	9051222-77-10-pp
9041224-77-10-pp	1/2"	SW24	77	77	36	36	9051224-77-10-pp
9041227-77-10-pp	1/2"	SW27	77	77	40	40	9051227-77-10-pp
9041230-77-10-pp	1/2"	SW30	77	77	43,5	43,5	9051230-77-10-pp
9041232-77-10-pp	1/2"	SW32	77	77	46,5	46,5	9051232-77-10-pp

covertec 1/2"



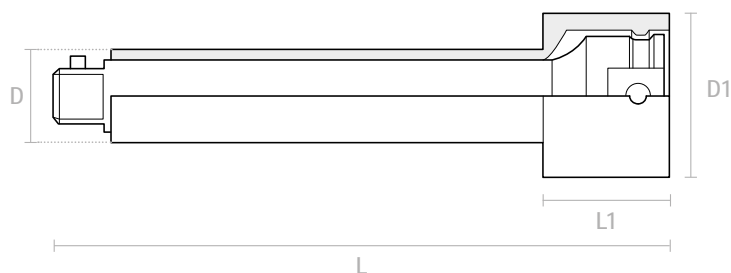

Prodloužení 1/2"

Extension 1/2"

Kód	Pohon	Výstup	L	L1	D1	D	Náhr. pouzdra
Code	Input	Output	L	L1	D1	D	Repl. Sleeves
9060007	1/2"	1/2"	75	38,5	36	20	9061007
9060018	1/2"	1/2"	100	38,5	36	20	9061018
9060008	1/2"	1/2"	125	38,5	36	20	9061008
9060062	1/2"	1/2"	150	38,5	36	20	9061080
9060032	1/2"	1/2"	200	38,5	36	20	9061032
9060009	1/2"	1/2"	250	38,5	36	20	9061009
9060033	1/2"	1/2"	300	38,5	36	20	9061033
9060034	1/2"	1/2"	400	38,5	36	20	9061034
9060046	1/2"	1/2"	450	38,5	36	20	9061046
9060060	1/2"	1/2"	500	38,5	36	20	9061060
9060061	1/2"	1/2"	510	38,5	36	20	9061061

Prodloužení 1/2" tenkostěnné

Extension 1/2" thin walled



Kód	Pohon	Výstup	L	L1	D1	D	Náhr. pouzdra
Code	Input	Output	L	L1	D1	D	Repl. Sleeves
9060007-10	1/2"	1/2"	75	36	27	20	9061007-10
9060008-10	1/2"	1/2"	125	36	27	20	9061008-10
9060009-10	1/2"	1/2"	250	36	27	20	9061009-10

covertec 1/2"

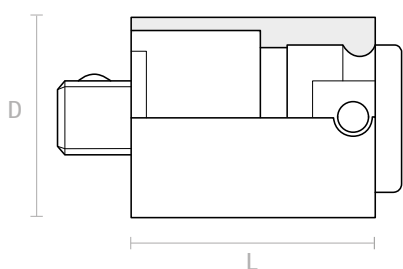

Rychlovýměnné sklíčidlo 1/2"

Quick-release 1/2"

Kód	Pohon	Výstup	D	L
Code	Input	Output	D	L
9092007	1/2"	C8	32	50
9092008	1/2"	E6,3	32	50
9092009	1/2"	1/2"	32	60

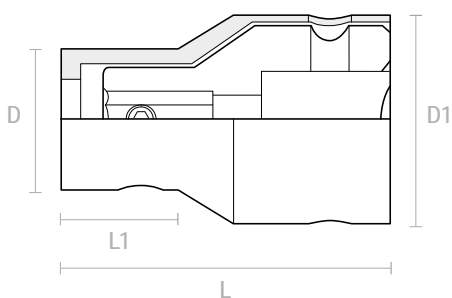

Držák bitů 1/2"
Bit holder 1/2"

Kód	Pohon	Výstup	L	L1	D1	D	Bit
Code	Input	Output	L	L1	D1	D	Bit
9091014	1/2"	C6,3	44	15,5	27,5	19	C6,3
9091014	1/2"	C6,3	44	15,5	27,5	19	E6,3
9091015	1/2"	C8	44	44	27,5	27,5	C8
9091016	1/2"	C11	44	44	34	34	C11
9091018	1/2"	C8	37	75	28	20	C8

3



4

covertec 3/4"

covertec nářadí

covertec tools

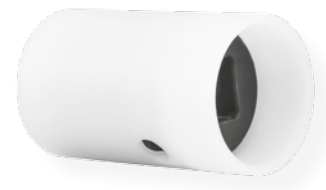
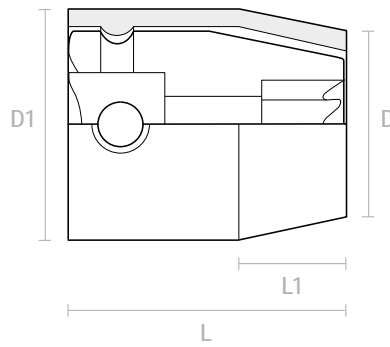

Pinch-point

Nástrčná hlavice 6-ti hranná L50 6-point socket L50



Kód	Pohon	Výstup	L	L1	D1	D	Náhr. pouzdra
Code	Input	Output	L	L1	D1	D	Repl. Sleeves
9041134	3/4"	SW17	50	24	47,5	35	9051134
9041135	3/4"	SW18	50	24	47,5	36	9051135
9041136	3/4"	SW19	50	24	47,5	37	9051136
9041137	3/4"	SW21	50	24	47,5	41	9051137
9041138	3/4"	SW22	50	24	47,5	42	9051138
9041139	3/4"	SW24	50	24	47,5	44,5	9051139
9041140	3/4"	SW27	50	26	49,5	46,5	9051140
9041046	3/4"	SW30	50	28,5	49,5	51,5	9051046
9041142	3/4"	SW32	50	29	49,5	52,5	9051142
9041143	3/4"	SW34	50	34	49,5	56	9051143
9041144	3/4"	SW36	50	31	49,5	59	9051144
9041145	3/4"	SW41	50	34	49,5	65	9051145
9041146	3/4"	SW46	50	37	45	71	9051146

Nástrčná hlavice 6-ti hranná L50, Pinch-point 6-point socket L50, Pinch-point



Kód	Pohon	Výstup	L	L1	D1	D	Náhr. pouzdra
Code	Input	Output	L	L1	D1	D	Repl. Sleeves
9041134-pp	3/4"	SW17	50	24	47,5	35	9051134-pp
9041135-pp	3/4"	SW18	50	24	47,5	36	9051135-pp
9041136-pp	3/4"	SW19	50	24	47,5	37	9051136-pp
9041137-pp	3/4"	SW21	50	24	47,5	41	9051137-pp
9041138-pp	3/4"	SW22	50	24	47,5	42	9051138-pp
9041139-pp	3/4"	SW24	50	24	47,5	44,5	9051139-pp
9041140-pp	3/4"	SW27	50	26	49,5	46,5	9051140-pp
9041046-pp	3/4"	SW30	50	28,5	49,5	51,5	9051046-pp
9041142-pp	3/4"	SW32	50	29	49,5	52,5	9051142-pp
9041143-pp	3/4"	SW34	50	34	49,5	56	9051143-pp
9041144-pp	3/4"	SW36	50	31	49,5	59	9051144-pp
9041145-pp	3/4"	SW41	50	34	49,5	65	9051145-pp
9041146-pp	3/4"	SW46	50	37	45	71	9051146-pp

Nástrčná hlavice L50, Torx Socket L50, Torx



Kód	Pohon	Výstup	L	L1	D1	D	Náhr. pouzdra
Code	Input	Output	L	L1	D1	D	Repl. Sleeves
9041199	3/4"	E18	50	24	47,5	30	9051199
9041207	3/4"	E20	50	24	47,5	33	9051207
9041201	3/4"	E22	50	24	47,5	35	9051201
9041202	3/4"	E24	50	24	47,5	36	9051202

Nástrčná hlavice L50, Pinch-point, Torx Socket L50, Pinch-point, Torx



Kód	Pohon	Výstup	L	L1	D1	D	Náhr. pouzdra
Code	Input	Output	L	L1	D1	D	Repl. Sleeves
9041199-pp	3/4"	E18	50	24	47,5	30	9051199-pp
9041207-pp	3/4"	E20	50	24	47,5	33	9051207-pp
9041201-pp	3/4"	E22	50	24	47,5	35	9051201-pp
9041202-pp	3/4"	E24	50	24	47,5	36	9051202-pp

covertec 3/4"

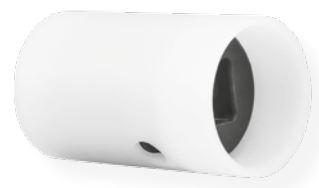
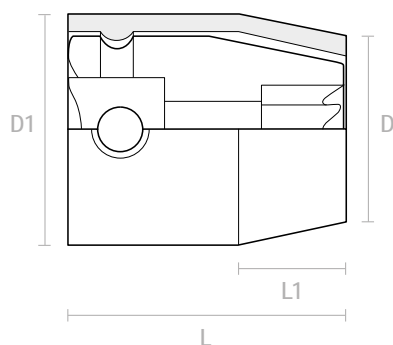

Pinch-point

Nástrčná hlavice 6-ti hranná s tyčovým magnetem L50
6-point socket with central magnet L50



Kód	Pohon	Výstup	L	L1	D1	D	Náhr. pouzdra
Code	Input	Output	L	L1	D1	D	Repl. Sleeves
9041134-1	3/4"	SW17	50	24	47,5	35	9051134-1
9041135-1	3/4"	SW18	50	24	47,5	36	9051135-1
9041136-1	3/4"	SW19	50	24	47,5	37	9051136-1
9041137-1	3/4"	SW21	50	24	47,5	41	9051137-1
9041138-1	3/4"	SW22	50	24	47,5	42	9051138-1
9041139-1	3/4"	SW24	50	24	47,5	44,5	9051139-1
9041140-1	3/4"	SW27	50	26	49,5	46,5	9051140-1
9041046-1	3/4"	SW30	50	28,5	49,5	51,5	9051046-1
9041142-1	3/4"	SW32	50	29	49,5	52,5	9051142-1
9041143-1	3/4"	SW34	50	34	49,5	56	9051143-1
9041144-1	3/4"	SW36	50	31	49,5	59	9051144-1
9041145-1	3/4"	SW41	50	34	49,5	65	9051145-1
9041146-1	3/4"	SW46	50	37	45	71	9051146-1

Nástrčná hlavice 6-ti hranná s tyčovým magnetem L50, Pinch-p.
6-point socket with central magnet L50, Pinch-point



Kód	Pohon	Výstup	L	L1	D1	D	Náhr. pouzdra
Code	Input	Output	L	L1	D1	D	Repl. Sleeves
9041134-1-pp	3/4"	SW17	50	24	47,5	35	9051134-1-pp
9041135-1-pp	3/4"	SW18	50	24	47,5	36	9051135-1-pp
9041136-1-pp	3/4"	SW19	50	24	47,5	37	9051136-1-pp
9041137-1-pp	3/4"	SW21	50	24	47,5	41	9051137-1-pp
9041138-1-pp	3/4"	SW22	50	24	47,5	42	9051138-1-pp
9041139-1-pp	3/4"	SW24	50	24	47,5	44,5	9051139-1-pp
9041140-1-pp	3/4"	SW27	50	26	49,5	46,5	9051140-1-pp
9041046-1-pp	3/4"	SW30	50	28,5	49,5	51,5	9051046-1-pp
9041142-1-pp	3/4"	SW32	50	29	49,5	52,5	9051142-1-pp
9041143-1-pp	3/4"	SW34	50	34	49,5	56	9051143-1-pp
9041144-1-pp	3/4"	SW36	50	31	49,5	59	9051144-1-pp
9041145-1-pp	3/4"	SW41	50	34	49,5	65	9051145-1-pp
9041146-1-pp	3/4"	SW46	50	37	45	71	9051146-1-pp

Nástrčná hlavice s tyčovým magnetem L50, Torx
Socket with central magnet L50, Torx



Kód	Pohon	Výstup	L	L1	D1	D	Náhr. pouzdra
Code	Input	Output	L	L1	D1	D	Repl. Sleeves
9041199-1	3/4"	E18	50	24	47,5	30	9051199-1
9041207-1	3/4"	E20	50	24	47,5	33	9051207-1
9041201-1	3/4"	E22	50	24	47,5	35	9051201-1
9041202-1	3/4"	E24	50	24	47,5	36	9051202-1

Nástrčná hlavice s tyčovým magnetem L50, Pinch-point, Torx
Socket with central magnet L50, Pinch-point, Torx



Kód	Pohon	Výstup	L	L1	D1	D	Náhr. pouzdra
Code	Input	Output	L	L1	D1	D	Repl. Sleeves
9041199-1-pp	3/4"	E18	50	24	47,5	30	9051199-1-pp
9041207-1-pp	3/4"	E20	50	24	47,5	33	9051207-1-pp
9041201-1-pp	3/4"	E22	50	24	47,5	35	9051201-1-pp
9041202-1-pp	3/4"	E24	50	24	47,5	36	9051202-1-pp

covertec 3/4"

covertec nářadí

covertec tools

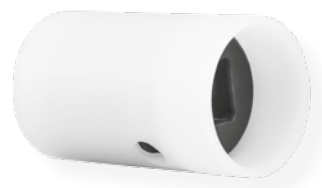
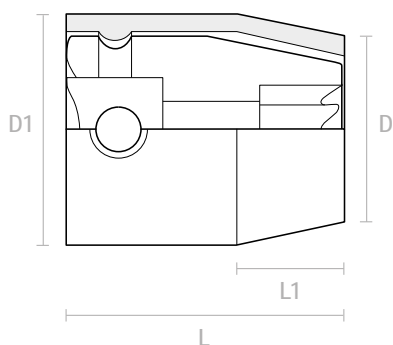

Pinch-point

Nástrčná hlavice 6-ti hranná 3 bodový magnet L50 6-point socket 3-point magnet L50



Kód	Pohon	Výstup	L	L1	D1	D	Náhr. pouzdra
Code	Input	Output	L	L1	D1	D	Repl. Sleeves
9041134-2	3/4"	SW17	50	24	47,5	35	9051134-2
9041135-2	3/4"	SW18	50	24	47,5	36	9051135-2
9041136-2	3/4"	SW19	50	24	47,5	37	9051136-2
9041137-2	3/4"	SW21	50	24	47,5	41	9051137-2
9041138-2	3/4"	SW22	50	24	47,5	42	9051138-2
9041139-2	3/4"	SW24	50	24	47,5	44,5	9051139-2
9041140-2	3/4"	SW27	50	26	49,5	46,5	9051140-2
9041046-2	3/4"	SW30	50	28,5	49,5	51,5	9051046-2
9041142-2	3/4"	SW32	50	29	49,5	52,5	9051142-2
9041143-2	3/4"	SW34	50	34	49,5	56	9051143-2
9041144-2	3/4"	SW36	50	31	49,5	59	9051144-2
9041145-2	3/4"	SW41	50	34	49,5	65	9051145-2
9041146-2	3/4"	SW46	50	37	45	71	9051146-2

Nástrčná hlavice Surface-drive L50 Socket surface-drive L50



Kód	Pohon	Výstup	L	L1	D1	D	Náhr. pouzdra
Code	Input	Output	L	L1	D1	D	Repl. Sleeves
9041134-4	3/4"	SW17	50	24	47,5	35	9051134-4
9041135-4	3/4"	SW18	50	24	47,5	36	9051135-4
9041136-4	3/4"	SW19	50	24	47,5	37	9051136-4
9041137-4	3/4"	SW21	50	24	47,5	41	9051137-4
9041138-4	3/4"	SW22	50	24	47,5	42	9051138-4
9041139-4	3/4"	SW24	50	24	47,5	44,5	9051139-4
9041140-4	3/4"	SW27	50	26	49,5	46,5	9051140-4
9041046-4	3/4"	SW30	50	28,5	49,5	51,5	9051046-4
9041142-4	3/4"	SW32	50	29	49,5	52,5	9051142-4
9041143-4	3/4"	SW34	50	34	49,5	56	9051143-4
9041144-4	3/4"	SW36	50	31	49,5	59	9051144-4
9041145-4	3/4"	SW41	50	34	49,5	65	9051145-4
9041146-4	3/4"	SW46	50	37	45	71	9051146-4

Nástrčná hlavice 6-ti hranná 3 bodový magnet L50, Pinch-point 6-point socket 3-Point-magnet L50, Pinch-point



Kód	Pohon	Výstup	L	L1	D1	D	Náhr. pouzdra
Code	Input	Output	L	L1	D1	D	Repl. Sleeves
9041134-2-pp	3/4"	SW17	50	24	47,5	35	9051134-2-pp
9041135-2-pp	3/4"	SW18	50	24	47,5	36	9051135-2-pp
9041136-2-pp	3/4"	SW19	50	24	47,5	37	9051136-2-pp
9041137-2-pp	3/4"	SW21	50	24	47,5	41	9051137-2-pp
9041138-2-pp	3/4"	SW22	50	24	47,5	42	9051138-2-pp
9041139-2-pp	3/4"	SW24	50	24	47,5	44,5	9051139-2-pp
9041140-2-pp	3/4"	SW27	50	26	49,5	46,5	9051140-2-pp
9041046-2-pp	3/4"	SW30	50	28,5	49,5	51,5	9051046-2-pp
9041142-2-pp	3/4"	SW32	50	29	49,5	52,5	9051142-2-pp
9041143-2-pp	3/4"	SW34	50	34	49,5	56	9051143-2-pp
9041144-2-pp	3/4"	SW36	50	31	49,5	59	9051144-2-pp
9041145-2-pp	3/4"	SW41	50	34	49,5	65	9051145-2-pp
9041146-2-pp	3/4"	SW46	50	37	45	71	9051146-2-pp

Nástrčná hlavice Surface-drive L50, Pinch-point Socket surface-drive L50, Pinch-point



Kód	Pohon	Výstup	L	L1	D1	D	Náhr. pouzdra
Code	Input	Output	L	L1	D1	D	Repl. Sleeves
9041134-4-pp	3/4"	SW17	50	24	47,5	35	9051134-4-pp
9041135-4-pp	3/4"	SW18	50	24	47,5	36	9051135-4-pp
9041136-4-pp	3/4"	SW19	50	24	47,5	37	9051136-4-pp
9041137-4-pp	3/4"	SW21	50	24	47,5	41	9051137-4-pp
9041138-4-pp	3/4"	SW22	50	24	47,5	42	9051138-4-pp
9041139-4-pp	3/4"	SW24	50	24	47,5	44,5	9051139-4-pp
9041140-4-pp	3/4"	SW27	50	26	49,5	46,5	9051140-4-pp
9041046-4-pp	3/4"	SW30	50	28,5	49,5	51,5	9051046-4-pp
9041142-4-pp	3/4"	SW32	50	29	49,5	52,5	9051142-4-pp
9041143-4-pp	3/4"	SW34	50	34	49,5	56	9051143-4-pp
9041144-4-pp	3/4"	SW36	50	31	49,5	59	9051144-4-pp
9041145-4-pp	3/4"	SW41	50	34	49,5	65	9051145-4-pp
9041146-4-pp	3/4"	SW46	50	37	45	71	9051146-4-pp

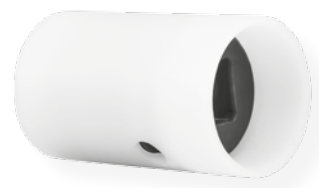
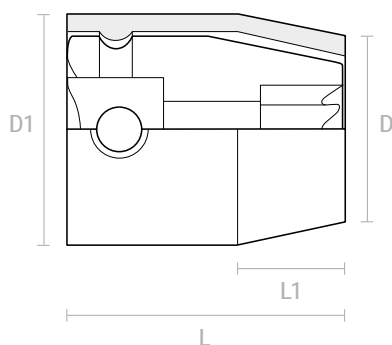

Pinch-point

Nástrčná hlavice dvojité 6-ti hran L50
12-point socket L50



Kód	Pohon	Výstup	L	L1	D1	D	Náhr. pouzdra
Code	Input	Output	L	L1	D1	D	Repl. Sleeves
9041134-5	3/4"	SW17	50	24	47,5	35	9051134-5
9041135-5	3/4"	SW18	50	24	47,5	36	9051135-5
9041136-5	3/4"	SW19	50	24	47,5	37	9051136-5
9041137-5	3/4"	SW21	50	24	47,5	41	9051137-5
9041138-5	3/4"	SW22	50	24	47,5	42	9051138-5
9041139-5	3/4"	SW24	50	24	47,5	44,5	9051139-5
9041140-5	3/4"	SW27	50	26	49,5	46,5	9051140-5
9041046-5	3/4"	SW30	50	28,5	49,5	51,5	9051046-5
9041142-5	3/4"	SW32	50	29	49,5	52,5	9051142-5
9041143-5	3/4"	SW34	50	34	49,5	56	9051143-5
9041144-5	3/4"	SW36	50	31	49,5	59	9051144-5
9041145-5	3/4"	SW41	50	34	49,5	65	9051145-5
9041146-5	3/4"	SW46	50	37	45	71	9051146-5

Nástrčná hlavice dvojité 6-ti hran L50, Pinch-point
12-point socket L50, Pinch-point



Kód	Pohon	Výstup	L	L1	D1	D	Náhr. pouzdra
Code	Input	Output	L	L1	D1	D	Repl. Sleeves
9041134-5-pp	3/4"	SW17	50	24	47,5	35	9051134-5-pp
9041135-5-pp	3/4"	SW18	50	24	47,5	36	9051135-5-pp
9041136-5-pp	3/4"	SW19	50	24	47,5	37	9051136-5-pp
9041137-5-pp	3/4"	SW21	50	24	47,5	41	9051137-5-pp
9041138-5-pp	3/4"	SW22	50	24	47,5	42	9051138-5-pp
9041139-5-pp	3/4"	SW24	50	24	47,5	44,5	9051139-5-pp
9041140-5-pp	3/4"	SW27	50	26	49,5	46,5	9051140-5-pp
9041046-5-pp	3/4"	SW30	50	28,5	49,5	51,5	9051046-5-pp
9041142-5-pp	3/4"	SW32	50	29	49,5	52,5	9051142-5-pp
9041143-5-pp	3/4"	SW34	50	34	49,5	56	9051143-5-pp
9041144-5-pp	3/4"	SW36	50	31	49,5	59	9051144-5-pp
9041145-5-pp	3/4"	SW41	50	34	49,5	65	9051145-5-pp
9041146-5-pp	3/4"	SW46	50	37	45	71	9051146-5-pp

covertec nářadí

covertec tools

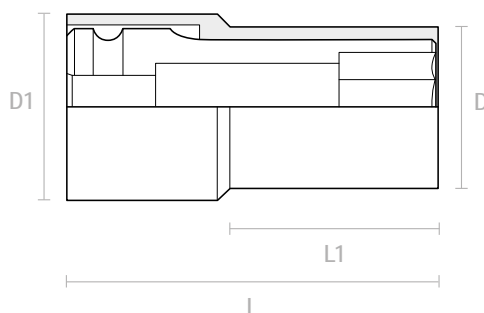

Pinch-point

Nástrčná hlavice 6-ti hranná L100 6-point socket L100



Kód	Pohon	Výstup	L	L1	D1	D	Náhr. pouzdra
Code	Input	Output	L	L1	D1	D	Repl. Sleeves
9041044	3/4"	SW17	100	53	49,5	35,5	9051044
9041147	3/4"	SW18	100	56	47,5	35	9051147
9041045	3/4"	SW19	100	52	49,5	36	9051045
9041148	3/4"	SW21	100	52	49,5	38,5	9051148
9041149	3/4"	SW22	100	47	49,5	42	9051149
9041150	3/4"	SW24	100	59	49,5	44	9051150
9041151	3/4"	SW27	100	66	50	47	9051151
9041152	3/4"	SW30	100	100	50	52	9051152
9041153	3/4"	SW32	100	100	50	54,5	9051153
9041154	3/4"	SW34	100	100	50	57	9051154
9041155	3/4"	SW36	100	100	50	60	9051155
9041156	3/4"	SW41	100	100	50	64	9051156
9041157	3/4"	SW46	100	100	50	72	9051157

Nástrčná hlavice 6-ti hranná L100, Pinch-point 6-point socket L100, Pinch-point



Kód	Pohon	Výstup	L	L1	D1	D	Náhr. pouzdra
Code	Input	Output	L	L1	D1	D	Repl. Sleeves
9041044-pp	3/4"	SW17	100	53	49,5	35,5	9051044-pp
9041147-pp	3/4"	SW18	100	56	47,5	35	9051147-pp
9041045-pp	3/4"	SW19	100	52	49,5	36	9051045-pp
9041148-pp	3/4"	SW21	100	52	49,5	38,5	9051148-pp
9041149-pp	3/4"	SW22	100	47	49,5	42	9051149-pp
9041150-pp	3/4"	SW24	100	59	49,5	44	9051150-pp
9041151-pp	3/4"	SW27	100	66	50	47	9051151-pp
9041152-pp	3/4"	SW30	100	100	50	52	9051152-pp
9041153-pp	3/4"	SW32	100	100	50	54,5	9051153-pp
9041154-pp	3/4"	SW34	100	100	50	57	9051154-pp
9041155-pp	3/4"	SW36	100	100	50	60	9051155-pp
9041156-pp	3/4"	SW41	100	100	50	64	9051156-pp
9041157-pp	3/4"	SW46	100	100	50	72	9051157-pp

Nástrčná hlavice L100, Torx Socket L100, Torx



Kód	Pohon	Výstup	L	L1	D1	D	Náhr. pouzdra
Code	Input	Output	L	L1	D1	D	Repl. Sleeves
9041203	3/4"	E18	100	53	47,5	31	9051203
9041204	3/4"	E20	100	53	49,5	34	9051204
9041205	3/4"	E22	100	53	49,5	36	9051205
9041206	3/4"	E24	100	54	49,5	37,5	9051206

Nástrčná hlavice L100, Pinch-point, Torx Socket L100, Pinch-point, Torx



Kód	Pohon	Výstup	L	L1	D1	D	Náhr. pouzdra
Code	Input	Output	L	L1	D1	D	Repl. Sleeves
9041203-pp	3/4"	E18	100	53	47,5	31	9051203-pp
9041204-pp	3/4"	E20	100	53	49,5	34	9051204-pp
9041205-pp	3/4"	E22	100	53	49,5	36	9051205-pp
9041206-pp	3/4"	E24	100	54	49,5	37,5	9051206-pp

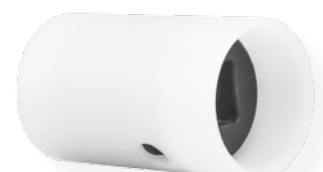
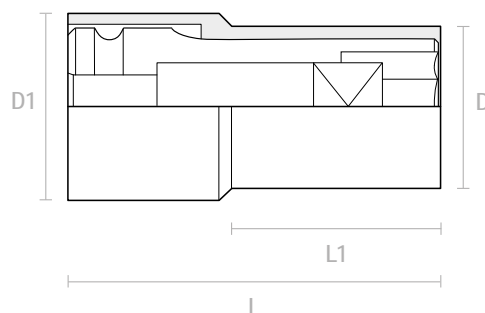

Pinch-point

Nástrčná hlavice 6-ti hranná s tyčovým magnetem L100

Socket with central magnet L100



Kód	Pohon	Výstup	L	L1	D1	D	Náhr. pouzdra
Code	Input	Output	L	L1	D1	D	Repl. Sleeves
9041044-1	3/4"	SW17	100	53	49,5	35,5	9051044-1
9041147-1	3/4"	SW18	100	56	47,5	35	9051147-1
9041045-1	3/4"	SW19	100	52	49,5	36	9051045-1
9041148-1	3/4"	SW21	100	52	49,5	38,5	9051148-1
9041149-1	3/4"	SW22	100	47	49,5	42	9051149-1
9041150-1	3/4"	SW24	100	59	49,5	44	9051150-1
9041151-1	3/4"	SW27	100	66	50	47	9051151-1
9041152-1	3/4"	SW30	100	100	50	52	9051152-1
9041153-1	3/4"	SW32	100	100	50	54,5	9051153-1
9041154-1	3/4"	SW34	100	100	50	57	9051154-1
9041155-1	3/4"	SW36	100	100	50	60	9051155-1
9041156-1	3/4"	SW41	100	100	50	64	9051156-1
9041157-1	3/4"	SW46	100	100	50	72	9051157-1

Nástrčná hlavice s tyčovým magnetem L100, Pinch-point

Socket with central magnet L100, Pinch-point



Kód	Pohon	Výstup	L	L1	D1	D	Náhr. pouzdra
Code	Input	Output	L	L1	D1	D	Repl. Sleeves
9041044-1-pp	3/4"	SW17	100	53	49,5	35,5	9051044-1-pp
9041147-1-pp	3/4"	SW18	100	56	47,5	35	9051147-1-pp
9041045-1-pp	3/4"	SW19	100	52	49,5	36	9051045-1-pp
9041148-1-pp	3/4"	SW21	100	52	49,5	38,5	9051148-1-pp
9041149-1-pp	3/4"	SW22	100	47	49,5	42	9051149-1-pp
9041150-1-pp	3/4"	SW24	100	59	49,5	44	9051150-1-pp
9041151-1-pp	3/4"	SW27	100	66	50	47	9051151-1-pp
9041152-1-pp	3/4"	SW30	100	100	50	52	9051152-1-pp
9041153-1-pp	3/4"	SW32	100	100	50	54,5	9051153-1-pp
9041154-1-pp	3/4"	SW34	100	100	50	57	9051154-1-pp
9041155-1-pp	3/4"	SW36	100	100	50	60	9051155-1-pp
9041156-1-pp	3/4"	SW41	100	100	50	64	9051156-1-pp
9041157-1-pp	3/4"	SW46	100	100	50	72	9051157-1-pp

Nástrčná hlavice s tyčovým magnetem L100, Torx

Socket with central magnet L100, Torx



Kód	Pohon	Výstup	L	L1	D1	D	Náhr. pouzdra
Code	Input	Output	L	L1	D1	D	Repl. Sleeves
9041203-1	3/4"	E18	100	53	47,5	31	9051203-1
9041204-1	3/4"	E20	100	53	49,5	34	9051204-1
9041205-1	3/4"	E22	100	53	49,5	36	9051205-1
9041206-1	3/4"	E24	100	54	49,5	37,5	9051206-1

Nástrčná hlavice s tyčovým magnetem L100, Pinch-point, Torx

Socket with central magnet L100, Pinch-point, Torx



Kód	Pohon	Výstup	L	L1	D1	D	Náhr. pouzdra
Code	Input	Output	L	L1	D1	D	Repl. Sleeves
9041203-1-pp	3/4"	E18	100	53	47,5	31	9051203-1-pp
9041204-1-pp	3/4"	E20	100	53	49,5	34	9051204-1-pp
9041205-1-pp	3/4"	E22	100	53	49,5	36	9051205-1-pp
9041206-1-pp	3/4"	E24	100	54	49,5	37,5	9051206-1-pp

covertec 3/4"

covertec nářadí

covertec tools

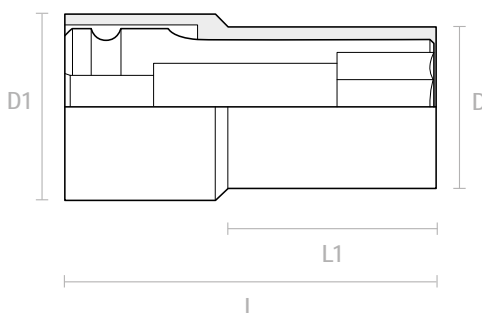

Pinch-point

Nástrčná hlavice 6-ti hranná 3 bodový magnet L100

6-point socket 3-point magnet L100



Kód	Pohon	Výstup	L	L1	D1	D	Náhr. pouzdra
Code	Input	Output	L	L1	D1	D	Repl. Sleeves
9041044-2	3/4"	SW17	100	53	49,5	35,5	9051044-2
9041147-2	3/4"	SW18	100	56	47,5	35	9051147-2
9041045-2	3/4"	SW19	100	52	49,5	36	9051045-2
9041148-2	3/4"	SW21	100	52	49,5	38,5	9051148-2
9041149-2	3/4"	SW22	100	47	49,5	42	9051149-2
9041150-2	3/4"	SW24	100	59	49,5	44	9051150-2
9041151-2	3/4"	SW27	100	66	50	47	9051151-2
9041152-2	3/4"	SW30	100	100	50	52	9051152-2
9041153-2	3/4"	SW32	100	100	50	54,5	9051153-2
9041154-2	3/4"	SW34	100	100	50	57	9051154-2
9041155-2	3/4"	SW36	100	100	50	60	9051155-2
9041156-2	3/4"	SW41	100	100	50	64	9051156-2
9041157-2	3/4"	SW46	100	100	50	72	9051157-2

Nástrčná hlavice Surface-drive L100

Socket surface-drive L100



Kód	Pohon	Výstup	L	L1	D1	D	Náhr. pouzdra
Code	Input	Output	L	L1	D1	D	Repl. Sleeves
9041044-4	3/4"	SW17sd	100	53	49,5	35,5	9051044-4
9041147-4	3/4"	SW18sd	100	56	47,5	35	9051147-4
9041045-4	3/4"	SW19sd	100	52	49,5	36	9051045-4
9041148-4	3/4"	SW21sd	100	52	49,5	38,5	9051148-4
9041149-4	3/4"	SW22sd	100	47	49,5	42	9051149-4
9041150-4	3/4"	SW24sd	100	59	49,5	44	9051150-4
9041151-4	3/4"	SW27sd	100	66	50	47	9051151-4
9041152-4	3/4"	SW30sd	100	100	50	52	9051152-4
9041153-4	3/4"	SW32sd	100	100	50	54,5	9051153-4
9041154-4	3/4"	SW34sd	100	100	50	57	9051154-4
9041155-4	3/4"	SW36sd	100	100	50	60	9051155-4
9041156-4	3/4"	SW41sd	100	100	50	64	9051156-4
9041157-4	3/4"	SW46sd	100	100	50	72	9051157-4

Nástrčná hlavice 6-ti hranná 3 bodový magnet L100, Pinch-point

6-point socket 3-point magnet L100, Pinch-point



Kód	Pohon	Výstup	L	L1	D1	D	Náhr. pouzdra
Code	Input	Output	L	L1	D1	D	Repl. Sleeves
9041044-2-pp	3/4"	SW17	100	53	49,5	35,5	9051044-2
9041147-2-pp	3/4"	SW18	100	56	47,5	35	9051147-2
9041045-2-pp	3/4"	SW19	100	52	49,5	36	9051045-2
9041148-2-pp	3/4"	SW21	100	52	49,5	38,5	9051148-2
9041149-2-pp	3/4"	SW22	100	47	49,5	42	9051149-2
9041150-2-pp	3/4"	SW24	100	59	49,5	44	9051150-2
9041151-2-pp	3/4"	SW27	100	66	50	47	9051151-2
9041152-2-pp	3/4"	SW30	100	100	50	52	9051152-2
9041153-2-pp	3/4"	SW32	100	100	50	54,5	9051153-2
9041154-2-pp	3/4"	SW34	100	100	50	57	9051154-2
9041155-2-pp	3/4"	SW36	100	100	50	60	9051155-2
9041156-2-pp	3/4"	SW41	100	100	50	64	9051156-2
9041157-2-pp	3/4"	SW46	100	100	50	72	9051157-2

Nástrčná hlavice Surface-drive L100, Pinch-point

Socket surface-drive L100, Pinch-point



Kód	Pohon	Výstup	L	L1	D1	D	Náhr. pouzdra
Code	Input	Output	L	L1	D1	D	Repl. Sleeves
9041044-4-pp	3/4"	SW17sd	100	53	49,5	35,5	9051044-4-pp
9041147-4-pp	3/4"	SW18sd	100	56	47,5	35	9051147-4-pp
9041045-4-pp	3/4"	SW19sd	100	52	49,5	36	9051045-4-pp
9041148-4-pp	3/4"	SW21sd	100	52	49,5	38,5	9051148-4-pp
9041149-4-pp	3/4"	SW22sd	100	47	49,5	42	9051149-4-pp
9041150-4-pp	3/4"	SW24sd	100	59	49,5	44	9051150-4-pp
9041151-4-pp	3/4"	SW27sd	100	66	50	47	9051151-4-pp
9041152-4-pp	3/4"	SW30sd	100	100	50	52	9051152-4-pp
9041153-4-pp	3/4"	SW32sd	100	100	50	54,5	9051153-4-pp
9041154-4-pp	3/4"	SW34sd	100	100	50	57	9051154-4-pp
9041155-4-pp	3/4"	SW36sd	100	100	50	60	9051155-4-pp
9041156-4-pp	3/4"	SW41sd	100	100	50	64	9051156-4-pp
9041157-4-pp	3/4"	SW46sd	100	100	50	72	9051157-4-pp

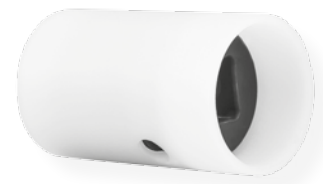
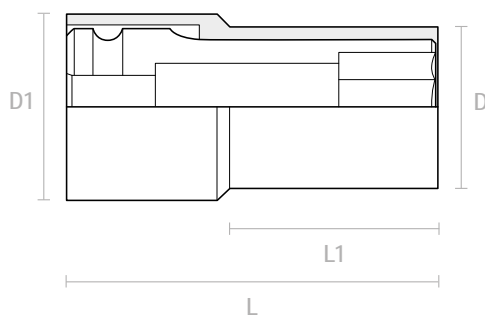

Pinch-point

Nástrčná hlavice dvojité 6-ti hran L100



Kód	Pohon	Výstup	L	L1	D1	D	Náhr. pouzdra
Code	Input	Output	L	L1	D1	D	Repl. Sleeves
9041044-5	3/4"	SW17	100	53	49,5	35,5	9051044-5
9041147-5	3/4"	SW18	100	56	47,5	35	9051147-5
9041045-5	3/4"	SW19	100	52	49,5	36	9051045-5
9041148-5	3/4"	SW21	100	52	49,5	38,5	9051148-5
9041149-5	3/4"	SW22	100	47	49,5	42	9051149-5
9041150-5	3/4"	SW24	100	59	49,5	44	9051150-5
9041151-5	3/4"	SW27	100	66	50	47	9051151-5
9041152-5	3/4"	SW30	100	100	50	52	9051152-5
9041153-5	3/4"	SW32	100	100	50	54,5	9051153-5
9041154-5	3/4"	SW34	100	100	50	57	9051154-5
9041155-5	3/4"	SW36	100	100	50	60	9051155-5
9041156-5	3/4"	SW41	100	100	50	64	9051156-5
9041157-5	3/4"	SW46	100	100	50	72	9051157-5

Nástrčná hlavice dvojité 6-ti hran L100, Pinch-point

12-point socket L100, Pinch-point



Kód	Pohon	Výstup	L	L1	D1	D	Náhr. pouzdra
Code	Input	Output	L	L1	D1	D	Repl. Sleeves
9041044-5-pp	3/4"	SW17	100	53	49,5	35,5	9051044-5-pp
9041147-5-pp	3/4"	SW18	100	56	47,5	35	9051147-5-pp
9041045-5-pp	3/4"	SW19	100	52	49,5	36	9051045-5-pp
9041148-5-pp	3/4"	SW21	100	52	49,5	38,5	9051148-5-pp
9041149-5-pp	3/4"	SW22	100	47	49,5	42	9051149-5-pp
9041150-5-pp	3/4"	SW24	100	59	49,5	44	9051150-5-pp
9041151-5-pp	3/4"	SW27	100	66	50	47	9051151-5-pp
9041152-5-pp	3/4"	SW30	100	100	50	52	9051152-5-pp
9041153-5-pp	3/4"	SW32	100	100	50	54,5	9051153-5-pp
9041154-5-pp	3/4"	SW34	100	100	50	57	9051154-5-pp
9041155-5-pp	3/4"	SW36	100	100	50	60	9051155-5-pp
9041156-5-pp	3/4"	SW41	100	100	50	64	9051156-5-pp
9041157-5-pp	3/4"	SW46	100	100	50	72	9051157-5-pp

covertec nářadí

covertec tools



covertec 3/4"

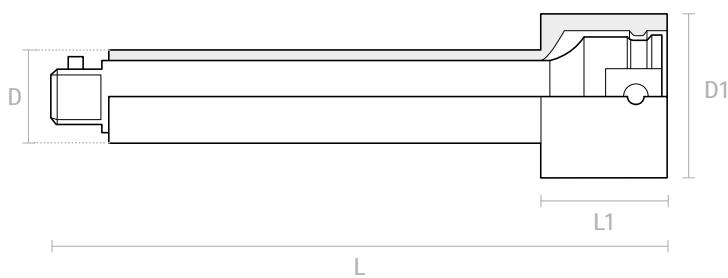

Prodloužení 3/4"

Extension 3/4"

Kód	Pohon	Výstup	L	L1	D1	D	Náhr. pouzdra
Code	Input	Output	L	L1	D1	D	Repl. Sleeves
9060041	3/4"	3/4"	175	55	50	32	9061041
9060040	3/4"	3/4"	250	55	50	32	9061040
9060042	3/4"	3/4"	320	55	50	32	9061042



covertec náradí

covertec tools

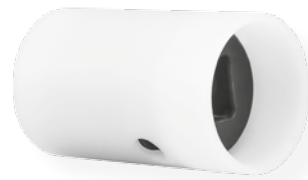
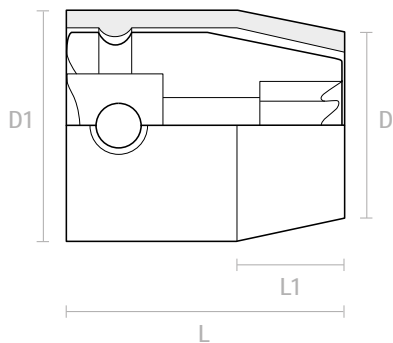

Pinch-point

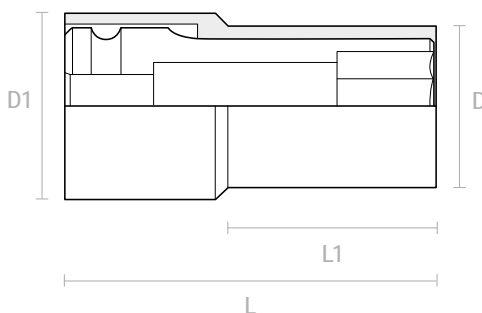

Nástrčná hlavice 6-ti hranná 1"
6-point socket 1"



Nástrčná hlavice 6-ti hranná 1", Pinch-point
6-point socket 1", Pinch-point



Kód	Pohon	Výstup	Form	L	L1	D1	D	Náhr. pouzdra
Code	In-/	Output	Form	L	L1	D1	D	Repl. Sleeves
9041158	1"	SW24	B	57	25	59	45	9051158
9041159	1"	SW27	B	57	25	59	50	9051159
9041160	1"	SW30	B	62	24	59	52	9051160
9041161	1"	SW32	B	62	24	59	55	9051161
9041162	1"	SW34	B	62	25	59	56	9051162
9041163	1"	SW36	B	62	30	59	60	9051163
9041164	1"	SW41	A	70	30	59	66	9051164
9041165	1"	SW46	A	70	30	59	72	9051165
9041166	1"	SW50	A	70	30	59	78	9051166
9041167	1"	SW55	A	75	30	59	80	9051167
9041168	1"	SW60	A	75	30	59	96	9051168
9041169	1"	SW65	A	75	30	59	101	9051169
9041170	1"	SW22	A	108	55	62	45	9051170
9041171	1"	SW24	A	108	55	62	45	9051171
9041172	1"	SW27	A	108	58	62	49	9051172
9041173	1"	SW30	A	108	60	62	55	9051173
9041174	1"	SW32	A	108	68	62	55,5	9051174
9041175	1"	SW34	A	108	68	62	57	9051175
9041176	1"	SW36	A	108	60	62	61	9051176
9041177	1"	SW41	A	108	60	62	67	9051177
9041178	1"	SW46	A	108	60	62	73	9051178
9041179	1"	SW50	A	108	60	62	78	9051179
9041180	1"	SW55	A	108	60	62	80	9051180
9041181	1"	SW60	A	108	60	62	96	9051181
9041182	1"	SW65	A	108	60	67	101	9051182

Kód	Pohon	Výstup	Form	L	L1	D1	D	Náhr. pouzdra
Code	In-/	Output	Form	L	L1	D1	D	Repl. Sleeves
9041158-pp	1"	SW24	B	57	25	59	45	9051158-pp
9041159-pp	1"	SW27	B	57	25	59	50	9051159-pp
9041160-pp	1"	SW30	B	62	24	59	52	9051160-pp
9041161-pp	1"	SW32	B	62	24	59	55	9051161-pp
9041162-pp	1"	SW34	B	62	25	59	56	9051162-pp
9041163-pp	1"	SW36	B	62	30	59	60	9051163-pp
9041164-pp	1"	SW41	A	70	30	59	66	9051164-pp
9041165-pp	1"	SW46	A	70	30	59	72	9051165-pp
9041166-pp	1"	SW50	A	70	30	59	78	9051166-pp
9041167-pp	1"	SW55	A	75	30	59	80	9051167-pp
9041168-pp	1"	SW60	A	75	30	59	96	9051168-pp
9041169-pp	1"	SW65	A	75	30	59	101	9051169-pp
9041170-pp	1"	SW22	A	108	55	62	45	9051170-pp
9041171-pp	1"	SW24	A	108	55	62	45	9051171-pp
9041172-pp	1"	SW27	A	108	58	62	49	9051172-pp
9041173-pp	1"	SW30	A	108	60	62	55	9051173-pp
9041174-pp	1"	SW32	A	108	68	62	55,5	9051174-pp
9041175-pp	1"	SW34	A	108	68	62	57	9051175-pp
9041176-pp	1"	SW36	A	108	60	62	61	9051176-pp
9041177-pp	1"	SW41	A	108	60	62	67	9051177-pp
9041178-pp	1"	SW46	A	108	60	62	73	9051178-pp
9041179-pp	1"	SW50	A	108	60	62	78	9051179-pp
9041180-pp	1"	SW55	A	108	60	62	80	9051180-pp
9041181-pp	1"	SW60	A	108	60	62	96	9051181-pp
9041182-pp	1"	SW65	A	108	60	67	101	9051182-pp

covertec 1"

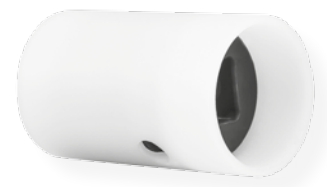
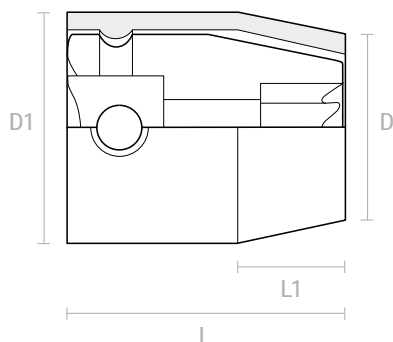

Pinch-point

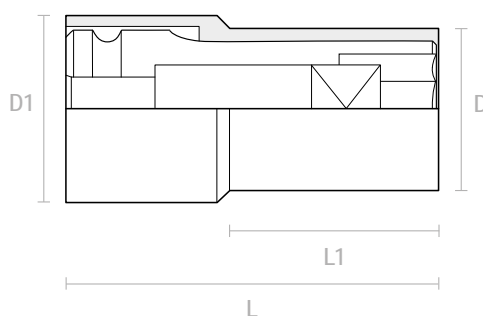

Nástrčná hlavice 6-ti hranná s tyčovým magnetem 1"
6-point socket with central magnet 1"



Nástrčná hlavice 6-ti hranná s tyčovým magnetem 1", Pinch-point
6-point socket with central magnet 1", Pinch-point



Kód	Pohon	Výstup	Form	L	L1	D1	D	Náhr. pouzdra
Code	In-/	Output	Form	L	L1	D1	D	Repl. Sleeves
9041158-1	1"	SW24	B	57	25	59	45	9051158-1
9041159-1	1"	SW27	B	57	25	59	50	9051159-1
9041160-1	1"	SW30	B	62	24	59	52	9051160-1
9041161-1	1"	SW32	B	62	24	59	55	9051161-1
9041162-1	1"	SW34	B	62	25	59	56	9051162-1
9041163-1	1"	SW36	B	62	30	59	60	9051163-1
9041164-1	1"	SW41	A	70	30	59	66	9051164-1
9041165-1	1"	SW46	A	70	30	59	72	9051165-1
9041166-1	1"	SW50	A	70	30	59	78	9051166-1
9041167-1	1"	SW55	A	75	30	59	80	9051167-1
9041168-1	1"	SW60	A	75	30	59	96	9051168-1
9041169-1	1"	SW65	A	75	30	59	101	9051169-1
9041170-1	1"	SW22	A	108	55	59	42	9051170-1
9041171-1	1"	SW24	A	108	55	59	45	9051171-1
9041172-1	1"	SW27	A	108	58	59	49	9051172-1
9041173-1	1"	SW30	A	108	60	59	55	9051173-1
9041174-1	1"	SW32	A	108	68	59	55,5	9051174-1
9041175-1	1"	SW34	A	108	68	59	57	9051175-1
9041176-1	1"	SW36	A	108	60	59	61	9051176-1
9041177-1	1"	SW41	A	108	60	59	67	9051177-1
9041178-1	1"	SW46	A	108	60	59	73	9051178-1
9041179-1	1"	SW50	A	108	60	59	78	9051179-1
9041180-1	1"	SW55	A	108	60	59	80	9051180-1
9041181-1	1"	SW60	A	108	60	59	96	9051181-1
9041182-1	1"	SW65	A	108	60	67	101	9051182-1

Kód	Pohon	Výstup	Form	L	L1	D1	D	Náhr. pouzdra
Code	In-/	Output	Form	L	L1	D1	D	Repl. Sleeves
9041158-1-pp	1"	SW24	B	57	25	59	45	9051158-1-pp
9041159-1-pp	1"	SW27	B	57	25	59	50	9051159-1-pp
9041160-1-pp	1"	SW30	B	62	24	59	52	9051160-1-pp
9041161-1-pp	1"	SW32	B	62	24	59	55	9051161-1-pp
9041162-1-pp	1"	SW34	B	62	25	59	56	9051162-1-pp
9041163-1-pp	1"	SW36	B	62	30	59	60	9051163-1-pp
9041164-1-pp	1"	SW41	A	70	30	59	66	9051164-1-pp
9041165-1-pp	1"	SW46	A	70	30	59	72	9051165-1-pp
9041166-1-pp	1"	SW50	A	70	30	59	78	9051166-1-pp
9041167-1-pp	1"	SW55	A	75	30	59	80	9051167-1-pp
9041168-1-pp	1"	SW60	A	75	30	59	96	9051168-1-pp
9041169-1-pp	1"	SW65	A	75	30	59	101	9051169-1-pp
9041170-1-pp	1"	SW22	A	108	55	59	42	9051170-1-pp
9041171-1-pp	1"	SW24	A	108	55	59	45	9051171-1-pp
9041172-1-pp	1"	SW27	A	108	58	59	49	9051172-1-pp
9041173-1-pp	1"	SW30	A	108	60	59	55	9051173-1-pp
9041174-1-pp	1"	SW32	A	108	68	59	55,5	9051174-1-pp
9041175-1-pp	1"	SW34	A	108	68	59	57	9051175-1-pp
9041176-1-pp	1"	SW36	A	108	60	59	61	9051176-1-pp
9041177-1-pp	1"	SW41	A	108	60	59	67	9051177-1-pp
9041178-1-pp	1"	SW46	A	108	60	59	73	9051178-1-pp
9041179-1-pp	1"	SW50	A	108	60	59	78	9051179-1-pp
9041180-1-pp	1"	SW55	A	108	60	59	80	9051180-1-pp
9041181-1-pp	1"	SW60	A	108	60	59	96	9051181-1-pp
9041182-1-pp	1"	SW65	A	108	60	67	101	9051182-1-pp

covertec nářadí

covertec tools

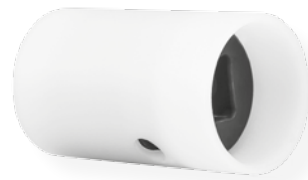
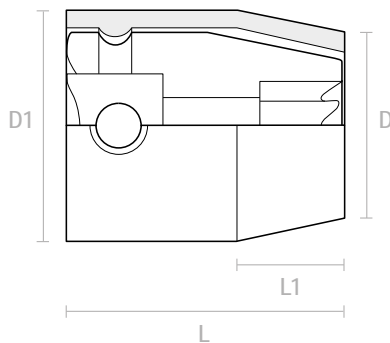

Pinch-point

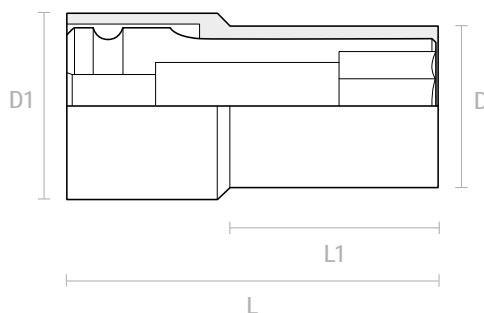

Nástrčná hlavice Surface-drive 1"
Socket surface-drive 1"



Nástrčná hlavice Surface-drive 1", Pinch-point
Socket surface-drive 1", Pinch-point



Kód	Pohon	Výstup	Form	L	L1	D1	D	Náhr. pouzdra
Code	In-/	Output	Form	L	L1	D1	D	Repl. Sleeves
9041158-4	1"	SW24	B	57	25	59	45	9051158-4
9041159-4	1"	SW27	B	57	25	59	50	9051159-4
9041160-4	1"	SW30	B	62	24	59	52	9051160-4
9041161-4	1"	SW32	B	62	24	59	55	9051161-4
9041162-4	1"	SW34	B	62	25	59	56	9051162-4
9041163-4	1"	SW36	B	62	30	59	60	9051163-4
9041164-4	1"	SW41	A	70	30	59	66	9051164-4
9041165-4	1"	SW46	A	70	30	59	72	9051165-4
9041166-4	1"	SW50	A	70	30	59	78	9051166-4
9041167-4	1"	SW55	A	75	30	59	80	9051167-4
9041168-4	1"	SW60	A	75	30	59	96	9051168-4
9041169-4	1"	SW65	A	75	30	59	101	9051169-4
9041170-4	1"	SW22	A	108	55	59	42	9051170-4
9041171-4	1"	SW24	A	108	55	59	45	9051171-4
9041172-4	1"	SW27	A	108	58	59	49	9051172-4
9041173-4	1"	SW30	A	108	60	59	55	9051173-4
9041174-4	1"	SW32	A	108	68	59	55,5	9051174-4
9041175-4	1"	SW34	A	108	68	59	57	9051175-4
9041176-4	1"	SW36	A	108	60	59	61	9051176-4
9041177-4	1"	SW41	A	108	60	59	67	9051177-4
9041178-4	1"	SW46	A	108	60	59	73	9051178-4
9041179-4	1"	SW50	A	108	60	59	78	9051179-4
9041180-4	1"	SW55	A	108	60	59	80	9051180-4
9041181-4	1"	SW60	A	108	60	59	96	9051181-4
9041182-4	1"	SW65	A	108	60	67	101	9051182-4

Kód	Pohon	Výstup	Form	L	L1	D1	D	Náhr. pouzdra
Code	In-/	Output	Form	L	L1	D1	D	Repl. Sleeves
9041158-4-pp	1"	SW24	B	57	25	59	45	9051158-4-pp
9041159-4-pp	1"	SW27	B	57	25	59	50	9051159-4-pp
9041160-4-pp	1"	SW30	B	62	24	59	52	9051160-4-pp
9041161-4-pp	1"	SW32	B	62	24	59	55	9051161-4-pp
9041162-4-pp	1"	SW34	B	62	25	59	56	9051162-4-pp
9041163-4-pp	1"	SW36	B	62	30	59	60	9051163-4-pp
9041164-4-pp	1"	SW41	A	70	30	59	66	9051164-4-pp
9041165-4-pp	1"	SW46	A	70	30	59	72	9051165-4-pp
9041166-4-pp	1"	SW50	A	70	30	59	78	9051166-4-pp
9041167-4-pp	1"	SW55	A	75	30	59	80	9051167-4-pp
9041168-4-pp	1"	SW60	A	75	30	59	96	9051168-4-pp
9041169-4-pp	1"	SW65	A	75	30	59	101	9051169-4-pp
9041170-4-pp	1"	SW22	A	108	55	59	42	9051170-4-pp
9041171-4-pp	1"	SW24	A	108	55	59	45	9051171-4-pp
9041172-4-pp	1"	SW27	A	108	58	59	49	9051172-4-pp
9041173-4-pp	1"	SW30	A	108	60	59	55	9051173-4-pp
9041174-4-pp	1"	SW32	A	108	68	59	55,5	9051174-4-pp
9041175-4-pp	1"	SW34	A	108	68	59	57	9051175-4-pp
9041176-4-pp	1"	SW36	A	108	60	59	61	9051176-4-pp
9041177-4-pp	1"	SW41	A	108	60	59	67	9051177-4-pp
9041178-4-pp	1"	SW46	A	108	60	59	73	9051178-4-pp
9041179-4-pp	1"	SW50	A	108	60	59	78	9051179-4-pp
9041180-4-pp	1"	SW55	A	108	60	59	80	9051180-4-pp
9041181-4-pp	1"	SW60	A	108	60	59	96	9051181-4-pp
9041182-4-pp	1"	SW65	A	108	60	67	101	9051182-4-pp

covertec 1"

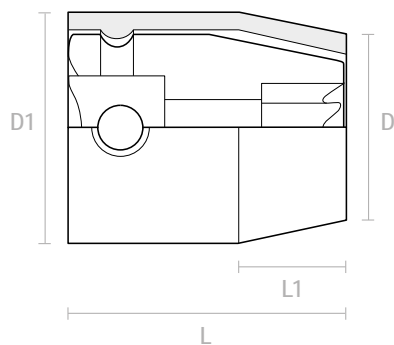

Pinch-point

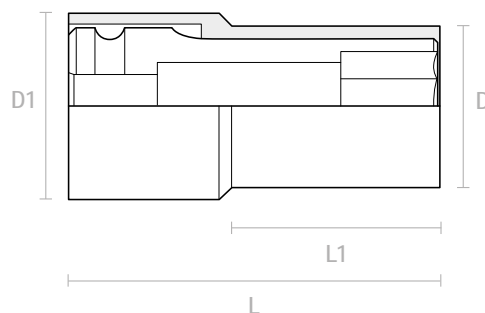

Nástrčná hlavice dvojité 6-ti hran 1"
12-point socket 1"



Nástrčná hlavice dvojité 6-ti hran 1", Pinch-point
12-point socket 1", Pinch-point



Kód	Pohon	Výstup	Form	L	L1	D1	D	Náhr. pouzdra
Code	In-/	Output	Form	L	L1	D1	D	Repl. Sleeves
9041158-5	1"	SW24	B	57	25	59	45	9051158-5
9041159-5	1"	SW27	B	57	25	59	50	9051159-5
9041160-5	1"	SW30	B	62	24	59	52	9051160-5
9041161-5	1"	SW32	B	62	24	59	55	9051161-5
9041162-5	1"	SW34	B	62	25	59	56	9051162-5
9041163-5	1"	SW36	B	62	30	59	60	9051163-5
9041164-5	1"	SW41	A	70	30	59	66	9051164-5
9041165-5	1"	SW46	A	70	30	59	72	9051165-5
9041166-5	1"	SW50	A	70	30	59	78	9051166-5
9041167-5	1"	SW55	A	75	30	59	80	9051167-5
9041168-5	1"	SW60	A	75	30	59	96	9051168-5
9041169-5	1"	SW65	A	75	30	59	101	9051169-5
9041170-5	1"	SW22	A	108	55	59	42	9051170-5
9041171-5	1"	SW24	A	108	55	59	45	9051171-5
9041172-5	1"	SW27	A	108	58	59	49	9051172-5
9041173-5	1"	SW30	A	108	60	59	55	9051173-5
9041174-5	1"	SW32	A	108	68	59	55,5	9051174-5
9041175-5	1"	SW34	A	108	68	59	57	9051175-5
9041176-5	1"	SW36	A	108	60	59	61	9051176-5
9041177-5	1"	SW41	A	108	60	59	67	9051177-5
9041178-5	1"	SW46	A	108	60	59	73	9051178-5
9041179-5	1"	SW50	A	108	60	59	78	9051179-5
9041180-5	1"	SW55	A	108	60	59	80	9051180-5
9041181-5	1"	SW60	A	108	60	59	96	9051181-5
9041182-5	1"	SW65	A	108	60	67	101	9051182-5

Kód	Pohon	Výstup	Form	L	L1	D1	D	Náhr. pouzdra
Code	In-/	Output	Form	L	L1	D1	D	Repl. Sleeves
9041158-5-pp	1"	SW24	B	57	25	59	45	9051158-5-pp
9041159-5-pp	1"	SW27	B	57	25	59	50	9051159-5-pp
9041160-5-pp	1"	SW30	B	62	24	59	52	9051160-5-pp
9041161-5-pp	1"	SW32	B	62	24	59	55	9051161-5-pp
9041162-5-pp	1"	SW34	B	62	25	59	56	9051162-5-pp
9041163-5-pp	1"	SW36	B	62	30	59	60	9051163-5-pp
9041164-5-pp	1"	SW41	A	70	30	59	66	9051164-5-pp
9041165-5-pp	1"	SW46	A	70	30	59	72	9051165-5-pp
9041166-5-pp	1"	SW50	A	70	30	59	78	9051166-5-pp
9041167-5-pp	1"	SW55	A	75	30	59	80	9051167-5-pp
9041168-5-pp	1"	SW60	A	75	30	59	96	9051168-5-pp
9041169-5-pp	1"	SW65	A	75	30	59	101	9051169-5-pp
9041170-5-pp	1"	SW22	A	108	55	59	42	9051170-5-pp
9041171-5-pp	1"	SW24	A	108	55	59	45	9051171-5-pp
9041172-5-pp	1"	SW27	A	108	58	59	49	9051172-5-pp
9041173-5-pp	1"	SW30	A	108	60	59	55	9051173-5-pp
9041174-5-pp	1"	SW32	A	108	68	59	55,5	9051174-5-pp
9041175-5-pp	1"	SW34	A	108	68	59	57	9051175-5-pp
9041176-5-pp	1"	SW36	A	108	60	59	61	9051176-5-pp
9041177-5-pp	1"	SW41	A	108	60	59	67	9051177-5-pp
9041178-5-pp	1"	SW46	A	108	60	59	73	9051178-5-pp
9041179-5-pp	1"	SW50	A	108	60	59	78	9051179-5-pp
9041180-5-pp	1"	SW55	A	108	60	59	80	9051180-5-pp
9041181-5-pp	1"	SW60	A	108	60	59	96	9051181-5-pp
9041182-5-pp	1"	SW65	A	108	60	67	101	9051182-5-pp

covertec 1"

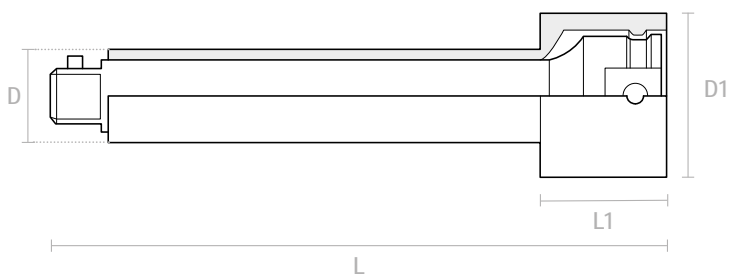

Prodloužení 6-ti hranné 1"

Extension 6-point 1"

Kód	Pohon	Výstup	L	L1	D1	D	Náhr. pouzdra
Code	Input	Output	L	L1	D1	D	Repl. Sleeves
9060043	1"	1"	175	60	60	40	9061041
9060044	1"	1"	250	60	60	40	9061040
9060045	1"	1"	330	60	60	40	9061042

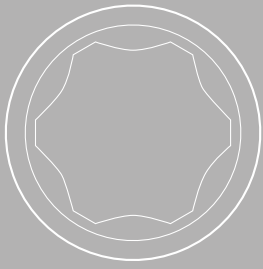

E6,3

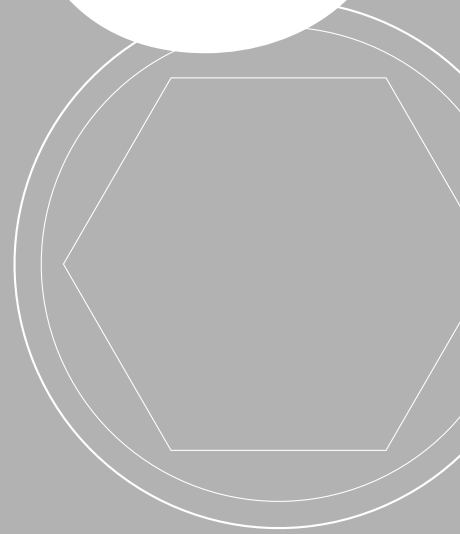

covertec nářadí

covertec tools

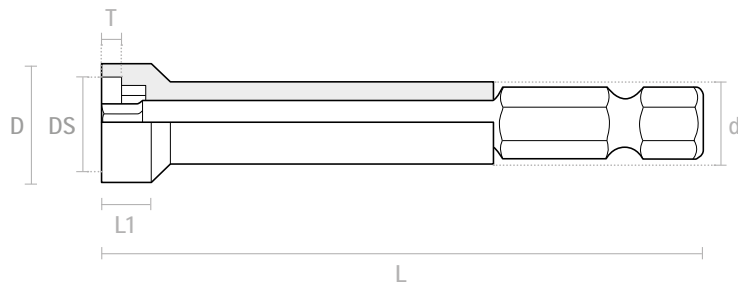

covertec Bit s magnetem, pevné pouzdro, Torx

covertec Bit with magnet, fix shell, Torx



Kód	Pohon	Výstup	L	L1	DS	D	T	d	Náhr. pouzdra
Code	In-/	Output	L	L1	DS	D	T	d	Repl. Sleeves
9010035-50-1	E6,3	T15	50	5,4	8,5	10,5	2,4	8,4	9011035-50
9010035-70-1	E6,3	T15	70	5,4	8,5	10,5	2,4	8,4	9011035-70
9010035-1	E6,3	T15	90	5,4	8,5	10,5	2,4	8,4	9011035-90
9010035-110-1	E6,3	T15	110	5,4	8,5	10,5	2,4	8,4	9011035-110
9010035-150-1	E6,3	T15	150	5,4	8,5	10,5	2,4	8,4	9011035-150
9010035-300-1	E6,3	T15	300	5,4	8,5	10,5	2,4	8,4	9011035-300
9010034-50-1	E6,3	T15	50	6	9,5	12,5	2,4	8,4	9011034-50
9010034-70-1	E6,3	T15	70	6	9,5	12,5	2,4	8,4	9011034-70
9010034-1	E6,3	T15	90	6	9,5	12,5	2,4	8,4	9011034-90
9010034-110-1	E6,3	T15	110	6	9,5	12,5	2,4	8,4	9011034-110
9010034-150-1	E6,3	T15	150	6	9,5	12,5	2,4	8,4	9011034-150
9010034-300-1	E6,3	T15	300	6	9,5	12,5	2,4	8,4	9011034-300
9010021-40-1	E6,3	T20	40	6	8	10,5	2,4	8,4	9011021-40
9010021-50-1	E6,3	T20	50	6	8	10,5	2,4	8,4	9011021-50
9010021-70-1	E6,3	T20	70	6	8	10,5	2,4	8,4	9011021-70
9010021-1	E6,3	T20	90	6	8	10,5	2,4	8,4	9011021
9010021-110-1	E6,3	T20	110	6	8	10,5	2,4	8,4	9011021-110
9010021-127-1	E6,3	T20	127	6	8	10,5	2,4	8,4	9011021-127
9010021-150-1	E6,3	T20	150	6	8	10,5	2,4	8,4	9011021-150
9010021-200-1	E6,3	T20	200	6	8	10,5	2,4	8,4	9011021-200
9010021-300-1	E6,3	T20	300	6	8	10,5	2,4	8,4	9011021-300
9010023-50-1	E6,3	T20	50	6	9,5	12,5	2,4	8,4	9011023-50
9010023-70-1	E6,3	T20	70	6	9,5	12,5	2,4	8,4	9011023-70
9010023--1	E6,3	T20	90	6	9,5	12,5	2,4	8,4	9011023-90
9010023-110-1	E6,3	T20	110	6	9,5	12,5	2,4	8,4	9011023-110
9010023-150-1	E6,3	T20	150	6	9,5	12,5	2,4	8,4	9011023-150
9010023-200-1	E6,3	T20	200	6	9,5	12,5	2,4	8,4	9011023-200
9010023-220-1	E6,3	T20	220	6	9,5	12,5	2,4	8,4	9011023-220
9010023-300-1	E6,3	T20	300	6	9,5	12,5	2,4	8,4	9011023-300

covertec Bit s magnetem, pevné pouzdro, Torx

covertec Bit with magnet fix shell, Torx



Kód	Pohon	Výstup	L	L1	DS	D	T	d	Náhr. pouzdra
Code	In-/	Output	L	L1	DS	D	T	d	Repl. Sleeves
9010025-50-1	E6,3	T20	50	6	11	15,5	2,4	8,4	9011025-50
9010025-70-1	E6,3	T20	70	6	11	15,5	2,4	8,4	9011025-70
9010025-1	E6,3	T20	90	6	11	15,5	2,4	8,4	9011025
9010025-110-1	E6,3	T20	110	6	11	15,5	2,4	8,4	9011025-110
9010025-127-1	E6,3	T20	127	6	11	15,5	2,4	8,4	9011025-127
9010025-150-1	E6,3	T20	150	6	11	15,5	2,4	8,4	9011025-150
9010025-250-1	E6,3	T20	250	6	11	15,5	2,4	8,4	9011025-250
9010025-300-1	E6,3	T20	300	6	11	15,5	2,4	8,4	9011025-300
9010033-50-1	E6,3	T20	50	6	9,5	12,5	2,4	8,4	9011033-50
9010033-70-1	E6,3	T20	70	6	9,5	12,5	2,4	8,4	9011033-70
9010033-1	E6,3	T20	90	6	9,5	12,5	2,4	8,4	9011033
9010033-110-1	E6,3	T20	110	6	9,5	12,5	2,4	8,4	9011033-110
9010033-150-1	E6,3	T20	150	6	9,5	12,5	2,4	8,4	9011033-150
9010033-300-1	E6,3	T20	300	6	9,5	12,5	2,4	8,4	9011033-300
9010022-50-1	E6,3	T25	50	6	8	10,5	2,4	8,4	9011022-50
9010022-70-1	E6,3	T25	70	6	8	10,5	2,4	8,4	9011022-70
9010022-1	E6,3	T25	90	6	8	10,5	2,4	8,4	9011022
9010022-110-1	E6,3	T25	110	6	8	10,5	2,4	8,4	9011022-110
9010022-150-1	E6,3	T25	150	6	8	10,5	2,4	8,4	9011022-150
9010022-300-1	E6,3	T25	300	6	8	10,5	2,4	8,4	9011022-300
9010024-50-1	E6,3	T25	50	6	9,5	12,5	2,4	8,4	9011024-50
9010024-70-1	E6,3	T25	70	6	9,5	12,5	2,4	8,4	9011024-70
9010024-1	E6,3	T25	90	6	9,5	12,5	2,4	8,4	9011024
9010024-110	E6,3	T25	110	6	9,5	12,5	2,4	8,4	9011024-110
9010024-150-1	E6,3	T25	150	6	9,5	12,5	2,4	8,4	9011024-150
9010024-300-1	E6,3	T25	300	6	9,5	12,5	2,4	8,4	9011024-300

covertec E6,3

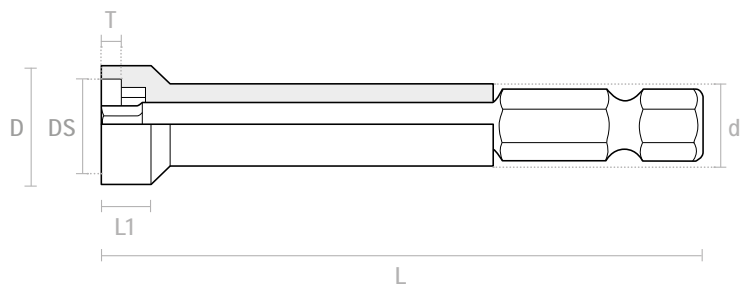

covertec Bit s magnetem, pevné pouzdro, Torx
covertec Bit with magnet, fix shell, Torx



Kód	Pohon	Výstup	L	L1	DS	D	T	d	Náhr. pouzdra
Code	In-/	Output	L	L1	DS	D	T	d	Repl. Sleeves
9010026-50-1	E6,3	T25	50	6	11	15,5	2,4	8,4	9011026-50
9010026-70-1	E6,3	T25	70	6	11	15,5	2,4	8,4	9011026-70
9010026-1	E6,3	T25	90	6	11	15,5	2,4	8,4	9011026
9010026-110-1	E6,3	T25	110	6	11	15,5	2,4	8,4	9011026-110
9010026-150-1	E6,3	T25	150	6	11	15,5	2,4	8,4	9011026-150
9010026-300-1	E6,3	T25	300	6	11	15,5	2,4	8,4	9011026-300
9010032-50-1	E6,3	T25	50	8	15	18	2,4	8,4	9011032-50
9010032-70-1	E6,3	T25	70	8	15	18	2,4	8,4	9011032-70
9010032-1	E6,3	T25	90	8	15	18	2,4	8,4	9011032
9010032-110-1	E6,3	T25	100	8	15	18	2,4	8,4	9011032-110
9010032-150-1	E6,3	T25	150	8	15	18	2,4	8,4	9011032-150
9010032-300-1	E6,3	T25	300	8	15	18	2,4	8,4	9011032-300
9010031-50-1	E6,3	T30	50	8	11,5	15,5	3	8,4	9011031-50
9010031-70-1	E6,3	T30	70	8	11,5	15,5	3	8,4	9011031-70
9010031-1	E6,3	T30	90	8	11,5	15,5	3	8,4	9011031
9010031-150-1	E6,3	T30	150	8	11,5	15,5	3	8,4	9011031-150
9010031-250-1	E6,3	T30	250	8	11,5	15,5	3	8,4	9011031-250
9010031-300-1	E6,3	T30	300	8	11,5	15,5	3	8,4	9011031-300
9010030-50-1	E6,3	T30	50	8	13	15,5	3	8,4	9011030-50
9010030-70-1	E6,3	T30	70	8	13	15,5	3	8,4	9011030-70
9010030-1	E6,3	T30	90	8	13	15,5	3	8,4	9011030
9010030-110-1	E6,3	T30	110	8	13	15,5	3	8,4	9011030-110
9010030-150-1	E6,3	T30	150	8	13	15,5	3	8,4	9011030-150
9010030-165-1	E6,3	T30	165	8	13	15,5	3	8,4	9011030-165
9010030-200-1	E6,3	T30	200	8	13	15,5	3	8,4	9011030-200
9010030-220-1	E6,3	T30	220	8	13	15,5	3	8,4	9011030-220
9010030-235-1	E6,3	T30	235	8	13	15,5	3	8,4	9011030-235
9010030-250-1	E6,3	T30	250	8	13	15,5	3	8,4	9011030-250
9010030-300-1	E6,3	T30	300	8	13	15,5	3	8,4	9011030-300

covertec Bit s magnetem, pevné pouzdro, Torx
covertec Bit with magnet, fix shell, Torx



Kód	Pohon	Výstup	L	L1	DS	D	T	d	Náhr. pouzdra
Code	In-/	Output	L	L1	DS	D	T	d	Repl. Sleeves
9010039-50-1	E6,3	T40	50	12	17	20	3,8	10,5	9011039-50
9010039-70-1	E6,3	T40	70	12	17	20	3,8	10,5	9011039-70
9010039-1	E6,3	T40	90	12	17	20	3,8	10,5	9011039
9010039-110-1	E6,3	T40	110	12	17	20	3,8	10,5	9011039-110
9010039-150-1	E6,3	T40	150	12	17	20	3,8	10,5	9011039-150
9010039-250-1	E6,3	T40	250	12	17	20	3,8	10,5	9011039-250
9010039-300-1	E6,3	T40	300	12	17	20	3,8	10,5	9011039-300
9010036-50-1	E6,3	T45	50	10	16	18,5	3,8	10,5	9011036-50
9010036-75-1	E6,3	T45	75	10	16	18,5	3,8	10,5	9011036-75
9010036-1	E6,3	T45	90	10	16	18,5	3,8	10,5	9011036
9010036-110	E6,3	T45	110	10	16	18,5	3,8	10,5	9011036-110
9010036-150-1	E6,3	T45	150	10	16	18,5	3,8	10,5	9011036-150
9010036-200-1	E6,3	T45	200	10	16	18,5	3,8	10,5	9011036-200
9010036-300-1	E6,3	T45	300	10	16	18,5	3,8	10,5	9011036-300
9010037-50-1	E6,3	T45	50	10	19	22	3,8	10,5	9011037-50
9010037-75-1	E6,3	T45	75	10	16	18,5	3,8	10,5	9011037-75
9010037-1	E6,3	T45	90	10	16	18,5	3,8	10,5	9011037-90
9010037-110-1	E6,3	T45	110	10	16	18,5	3,8	10,5	9011037-110
9010037-150-1	E6,3	T45	150	10	16	18,5	3,8	10,5	9011037-150
9010037-200-1	E6,3	T45	200	10	16	18,5	3,8	10,5	9011037-200
9010037-300-1	E6,3	T45	300	10	16	18,5	3,8	10,5	9011037-300

covertec nářadí

covertec tools

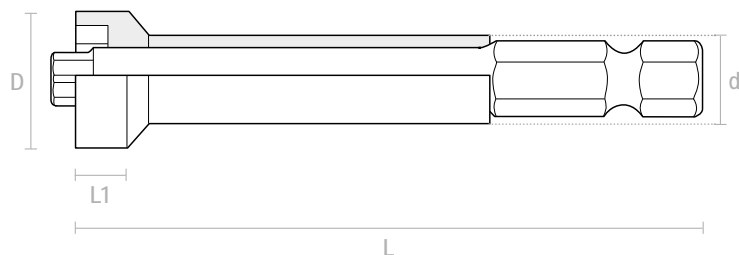

covertec Bit volná špička s magnetem, pevné pouzdro, Torx
covertec Bit lace free with magnet, fix shell, Torx



Kód	Pohon	Výstup	L	L1	D	d	Náhradní pouzdra
Code	In-/	Output	L	L1	D	d	Repl. Sleeves
2050756	E6,3	T15	50	5,4	10,5	8,4	2051756
2050757	E6,3	T15	70	5,4	10,5	8,4	2051757
2050758	E6,3	T15	90	5,4	10,5	8,4	2051758
2050759	E6,3	T15	150	5,4	10,5	8,4	2051759

covertec Bit volná špička s magnetem, pevné pouzdro, Torx
covertec Bit lace free with magnet, fix shell, torx



Kód	Pohon	Výstup	L	L1	D	d	Náhradní pouzdra
Code	In-/	Output	L	L1	D	d	Repl. Sleeves
9010035-50-2	E6,3	T15	50	5,4	10,5	8,4	9011035-50-2
9010035-70-2	E6,3	T15	70	5,4	10,5	8,4	9011035-70-2
9010035-90-2	E6,3	T15	90	5,4	10,5	8,4	9011035-90-2
9010035-110-2	E6,3	T15	110	5,4	10,5	8,4	9011035-110-2
9010035-150-2	E6,3	T15	150	5,4	10,5	8,4	9011035-150-2
9010035-300-2	E6,3	T15	300	5,4	10,5	8,4	9011035-300-2
9010021-50-2	E6,3	T20	50	6	10,5	8,4	9011021-50-2
9010021-70-2	E6,3	T20	70	6	10,5	8,4	9011021-70-2
9010021-2	E6,3	T20	90	6	10,5	8,4	9011021-2
9010021-110-2	E6,3	T20	110	6	10,5	8,4	9011021-110-2
9010021-127-2	E6,3	T20	127	6	10,5	8,4	9011021-127-2
9010021-150-2	E6,3	T20	150	6	10,5	8,4	9011021-150-2
9010021-200-2	E6,3	T20	200	6	10,5	8,4	9011021-200-2
9010021-300-2	E6,3	T20	300	6	10,5	8,4	9011021-300-2
9010022-50-2	E6,3	T25	50	6	10,5	8,4	9011022-50-2
9010022-70-2	E6,3	T25	70	6	10,5	8,4	9011022-70-2
9010022-2	E6,3	T25	90	6	10,5	8,4	9011022-2
9010022-110-2	E6,3	T25	110	6	10,5	8,4	9011022-110-2
9010022-150-2	E6,3	T25	150	6	10,5	8,4	9011022-150-2
9010022-300-2	E6,3	T25	300	6	10,5	8,4	9011022-300-2
9010030-50-2	E6,3	T30	50	8	15,5	8,4	9011030-50-2
9010030-70-2	E6,3	T30	70	8	15,5	8,4	9011030-70-2
9010030-2	E6,3	T30	90	8	15,5	8,4	9011030-2
9010030-110-2	E6,3	T30	110	8	15,5	8,4	9011030-110-2
9010030-150-2	E6,3	T30	150	8	15,5	8,4	9011030-150-2
9010030-165-2	E6,3	T30	165	8	15,5	8,4	9011030-165-2
9010030-200-2	E6,3	T30	200	8	15,5	8,4	9011030-200-2
9010030-220-2	E6,3	T30	220	8	15,5	8,4	9011030-220-2
9010030-235-2	E6,3	T30	235	8	15,5	8,4	9011030-235-2
9010030-250-2	E6,3	T30	250	8	15,5	8,4	9011030-250-2
9010030-300-2	E6,3	T30	300	8	15,5	8,4	9011030-300-2

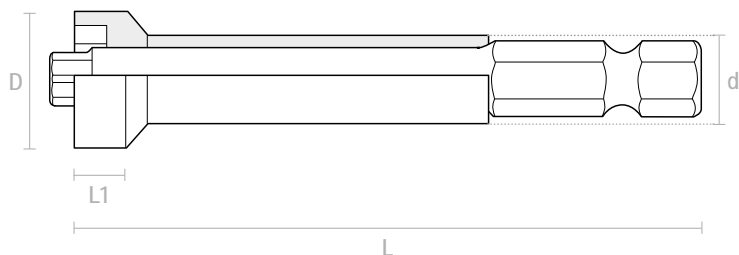

covertec Bit s přídržnou funkcí, pevné pouzdro, Torx
covertec Bit with holding function fix shell, Torx



Kód	Pohon	Výstup	L	L1	D	d	Náhradní pouzdra
Code	In-/	Output	L	L1	D	d	Repl. Sleeves
9010022-50-1-HF	E6,3	T25	50	6	10,5	8,4	9011022-50-1-HF
9010022-70-1-HF	E6,3	T25	70	6	10,5	8,4	9011022-70-1-HF
9010022-1-HF	E6,3	T25	90	6	10,5	8,4	9011022-1-HF
9010022-110-1-HF	E6,3	T25	100	6	10,5	8,4	9011022-110-1-HF
9010022-150-1-HF	E6,3	T25	150	6	10,5	8,4	9011022-150-1-HF
9010024-50-1-HF	E6,3	T25	50	6	12,5	8,4	9011024-50-1-HF
9010024-70-1-HF	E6,3	T25	70	6	12,5	8,4	9011024-70-1-HF
9010024-1-HF	E6,3	T25	90	6	12,5	8,4	9011024-1-HF
9010024-110-1-HF	E6,3	T25	110	6	12,5	8,4	9011024-110-1-HF
9010024-150-1-HF	E6,3	T25	150	6	12,5	8,4	9011024-150-1-HF
9010026-50-1-HF	E6,3	T25	50	6	15,5	8,4	9011026-50-1-HF
9010026-70-1-HF	E6,3	T25	70	6	15,5	8,4	9011026-70-1-HF
9010026-1-HF	E6,3	T25	90	6	15,5	8,4	9011026-1-HF
9010026-110-1-HF	E6,3	T25	110	6	15,5	8,4	9011026-110-1-HF
9010026-150-1-HF	E6,3	T25	150	6	15,5	8,4	9011026-150-1-HF
9010032-50-1-HF	E6,3	T25	50	8	18	8,4	9011032-50-1-HF
9010032-70-1-HF	E6,3	T25	70	8	18	8,4	9011032-70-1-HF
9010032-1-HF	E6,3	T25	90	8	18	8,4	9011032-1-HF
9010032-110-1-HF	E6,3	T25	110	8	18	8,4	9011032-110-1-HF
9010032-150-1-HF	E6,3	T25	150	8	18	8,4	9011032-150-1-HF
9010031-50-1-HF	E6,3	T30	50	8	15,5	8,4	9011031-50-1-HF
9010031-70-1-HF	E6,3	T30	70	8	15,5	8,4	9011031-70-1-HF
9010031-1-HF	E6,3	T30	90	8	15,5	8,4	9011031-1-HF
9010031-110-1-HF	E6,3	T30	110	8	15,5	8,4	9011031-110-1-HF
9010031-150-1-HF	E6,3	T30	150	8	15,5	8,4	9011031-150-1-HF

covertec Bit s přídržnou funkcí, pevné pouzdro, Torx
covertec Bit with holding function, fix shell, Torx



Kód	Pohon	Výstup	L	L1	D	d	Náhradní pouzdra
Code	In-/	Output	L	L1	D	d	Repl. Sleeves
9010030-50-1-HF	E6,3	T30	50	8	15,5	8,4	9011030-50-1-HF
9010030-70-1-HF	E6,3	T30	70	8	15,5	8,4	9011030-70-1-HF
9010030-1-HF	E6,3	T30	90	8	15,5	8,4	9011030-1-HF
9010030-110-1-HF	E6,3	T30	110	8	15,5	8,4	9011030-110-1-HF
9010030-150-1-HF	E6,3	T30	150	8	15,5	8,4	9011030-150-1-HF
9010039-50-1-HF	E6,3	T40	50	12	20	10,5	9011039-50-1-HF
9010039-70-1-HF	E6,3	T40	70	12	20	10,5	9011039-70-1-HF
9010039-1-HF	E6,3	T40	90	12	20	10,5	9011039-1-HF
9010039-110-1-HF	E6,3	T40	110	12	20	10,5	9011039-110-1-HF
9010039-150-1-HF	E6,3	T40	150	12	20	10,5	9011039-150-1-HF
9010036-50-1-HF	E6,3	T45	50	10	18,5	10,5	9011036-50-1-HF
9010036-75-1-HF	E6,3	T45	75	10	18,5	10,5	9011036-75-1-HF
9010036-1-HF	E6,3	T45	90	10	18,5	10,5	9011036-1-HF
9010036-110-1-HF	E6,3	T45	110	10	18,5	10,5	9011036-110-1-HF
9010036-150-1-HF	E6,3	T45	150	10	18,5	10,5	9011036-150-1-HF
9010036-200-1-HF	E6,3	T45	200	10	18,5	10,5	9011036-200-1-HF
9010037-50-1-HF	E6,3	T45	50	10	22	10,5	9011037-50-1-HF
9010037-75-1-HF	E6,3	T45	75	10	22	10,5	9011037-75-1-HF
9010037-90-1-HF	E6,3	T45	90	10	22	10,5	9011037-90-1-HF
9010037-110-1-HF	E6,3	T45	110	10	22	10,5	9011037-110-1-HF
9010037-150-1-HF	E6,3	T45	150	10	22	10,5	9011037-150-1-HF

covertec nářadí

covertec tools

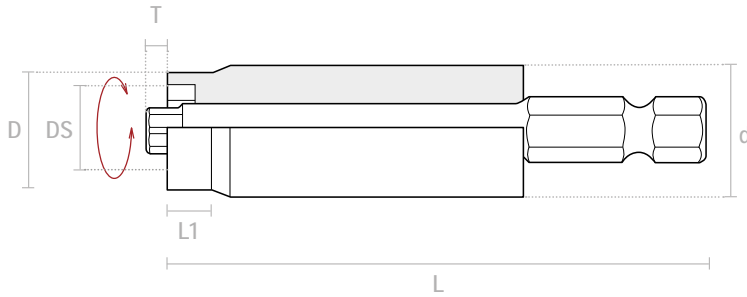

covertec Bit otočné pouzdro s magnetem, Torx
covertec Bit rotatable sleeve with magnet, Torx



Kód	Pohon	Výstup	L	L1	DS	D	T	d	Náhr. pouzdra
Code	In-/	Output	L	L1	DS	D	T	d	Repl. Sleeves
9010035-50-D	E6,3	T15	50	5,4	8,5	10,5	2,4	10	9011035-50-D
9010035-70-D	E6,3	T15	70	5,4	8,5	10,5	2,4	10	9011035-70-D
9010035-90-D	E6,3	T15	90	5,4	8,5	10,5	2,4	10	9011035-90-D
9010035-110-D	E6,3	T15	110	5,4	8,5	10,5	2,4	10	9011035-110-D
9010035-150-D	E6,3	T15	150	5,4	8,5	10,5	2,4	10	9011035-150-D
9010035-300-D	E6,3	T15	300	5,4	8,5	10,5	2,4	10	9011035-300-D
9010021-40-D	E6,3	T20	40	6	8	12	2,1	10	9011021-40-D
9010021-50-D	E6,3	T20	50	6	8	12	2,1	10	9011021-50-D
9010021-70-D	E6,3	T20	70	6	8	12	2,1	10	9011021-70-D
9010021-D	E6,3	T20	90	6	8	12	2,1	10	9011021-D
9010021-110-D	E6,3	T20	110	6	8	12	2,1	10	9011021-110-D
9010021-127-D	E6,3	T20	127	6	8	12	2,1	10	9011021-127-D
9010021-150-D	E6,3	T20	150	6	8	12	2,1	10	9011021-150-D
9010021-200-D	E6,3	T20	200	6	8	12	2,1	10	9011021-200-D
9010021-300-D	E6,3	T20	300	6	8	12	2,1	10	9011021-300-D

Covertec Bit otočné pouzdro s magnetem, Torx
covertec Bit rotatable sleeve with magnet, Torx



Kód	Pohon	Výstup	L	L1	DS	D	T	d	Náhr. pouzdra
Code	In-/	Output	L	L1	DS	D	T	d	Repl. Sleeves
9010033-50-D	E6,3	T20	50	6	9,5	12,5	2,1	12	9011033-50-D
9010033-70-D	E6,3	T20	70	6	9,5	12,5	2,1	12	9011033-70-D
9010033-D	E6,3	T20	90	6	9,5	12,5	2,1	12	9011033-D
9010033-110-D	E6,3	T20	110	6	9,5	12,5	2,1	12	9011033-110-D
9010033-150-D	E6,3	T20	150	6	9,5	12,5	2,1	12	9011033-150-D
9010033-300-D	E6,3	T20	300	6	9,5	12,5	2,1	12	9011033-300-D
9010022-50-D	E6,3	T25	50	6	8	10,5	2,4	10	9011022-50-D
9010022-70-D	E6,3	T25	70	6	8	10,5	2,4	10	9011022-70-D
9010022-D	E6,3	T25	90	6	8	10,5	2,4	10	9011022-D
9010022-110-D	E6,3	T25	110	6	8	10,5	2,4	10	9011022-110-D
9010022-150-D	E6,3	T25	150	6	8	10,5	2,4	10	9011022-150-D
9010022-300-D	E6,3	T25	300	6	8	10,5	2,4	10	9011022-300-D

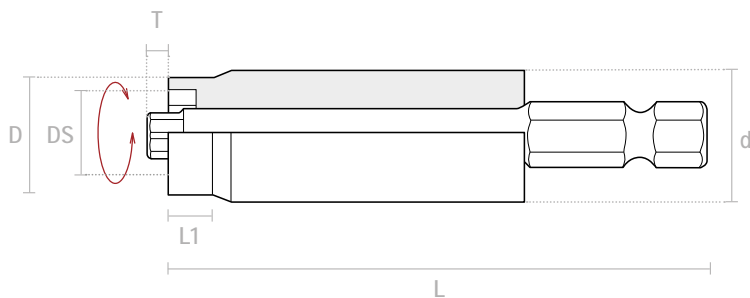

covertec Bit otočné pouzdro s magnetem, Torx
covertec Bit rotatable sleeve with magnet, Torx



Kód	Pohon	Výstup	L	L1	DS	D	T	d	Náhr. pouzdra
Code	In-/	Output	L	L1	DS	D	T	d	Repl. Sleeves
9010031-50-D	E6,3	T30	50	8	11,5	15,5	3	12	9011031-50-D
9010031-70-D	E6,3	T30	70	8	11,5	15,5	3	12	9011031-70-D
9010031-D	E6,3	T30	90	8	11,5	15,5	3	12	9011031-D
9010031-110-D	E6,3	T30	110	8	11,5	15,5	3	12	9011031-110-D
9010031-150-D	E6,3	T30	150	8	11,5	15,5	3	12	9011031-150-D
9010031-250-D	E6,3	T30	250	8	11,5	15,5	3	12	9011031-250-D
9010031-300-D	E6,3	T30	300	8	11,5	15,5	3	12	9011031-300-D

covertec Bit otočné pouzdro s magnetem, Torx
covertec Bit rotatable sleeve with magnet, Torx



Kód	Pohon	Výstup	L	L1	DS	D	T	d	Náhr. pouzdra
Code	In-/	Output	L	L1	DS	D	T	d	Repl. Sleeves
9010039-50-D	E6,3	T40	50	12	17	20	3,8	16	9011039-50-D
9010039-70-D	E6,3	T40	70	12	17	20	3,8	16	9011039-70-D
9010039-D	E6,3	T40	90	12	17	20	3,8	16	9011039-D
9010039-110-D	E6,3	T40	110	12	17	20	3,8	16	9011039-110-D
9010039-150-D	E6,3	T40	150	12	17	20	3,8	16	9011039-150-D
9010039-250-D	E6,3	T40	250	12	17	20	3,8	16	9011039-250-D
9010039-300-D	E6,3	T40	300	12	17	20	3,8	16	9011039-300-D

9010036-50-D	E6,3	T45	50	10	16	18,5	3,8	16	9011036-50-D
9010036-75-D	E6,3	T45	75	10	16	18,5	3,8	16	9011036-75-D
9010036-D	E6,3	T45	90	10	16	18,5	3,8	16	9011036-D
9010036-110-D	E6,3	T45	110	10	16	18,5	3,8	16	9011036-110-D
9010036-150-D	E6,3	T45	150	10	16	18,5	3,8	16	9011036-150-D
9010036-200-D	E6,3	T45	200	10	16	18,5	3,8	16	9011036-200-D
9010036-300-D	E6,3	T45	300	10	16	18,5	3,8	16	9011036-300-D



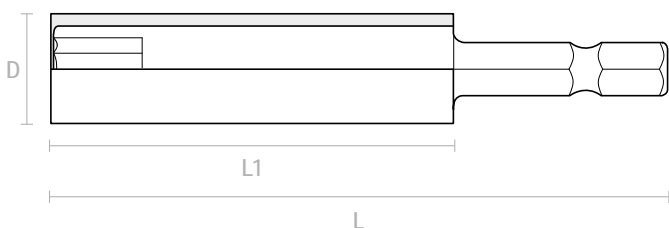

Držák bitů

Bit holder

Kód	Pohon	Výstup	L	L1	D1	Bit
Code	Input	Output	L	L1	D1	Bit
9091002	E6,3	C6,3	75	45	16,5	C6,3 L25
9091003	E6,3	C6,3	150	45	16,5	C6,3 L25
9091005	E6,3	C6,3	230	45	16,5	C6,3 L25
9091006	E6,3	C6,3	280	45	16,5	C6,3 L25
9091007	E6,3	C8	85	50	17	C8 L35
9091017	E6,3	C8	150	52	20	C8 L35
9091019	E6,3	C6,3	150	45	16,5	C6,3 L25
9091008	E6,3	C6,3	75	47	13	C6,3 L25

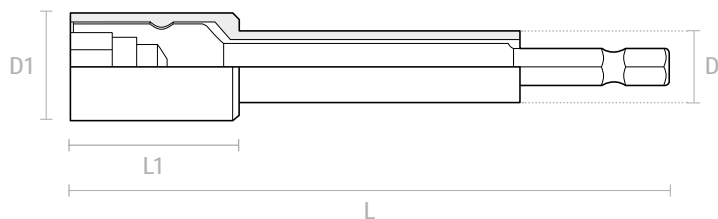

Nástavec bitů 6-ti hranný L50

Nut setters 6-point L50



Kód	Pohon	Výstup	L	L1	D1	D
Code	Input	Output	L	L1	D1	D
9041505-50	E6,3	SW5,5	50	25	12,5	-
9041506-50	E6,3	SW6	50	25	14	-
9041507-50	E6,3	SW7	50	25	14,5	-
9041508-50	E6,3	SW8	50	25	15,5	-
9041509-50	E6,3	SW9	50	25	16	-
9041510-50	E6,3	SW10	50	25	18	-
9041511-50	E6,3	SW11	50	25	18	-
9041512-50	E6,3	SW12	50	25	20	-
9041513-50	E6,3	SW13	50	25	22	-
9041514-50	E6,3	SW14	50	25	24	-
9041534-50	E6,3	E4	50	25	10	-
9041535-50	E6,3	E5	50	25	10	-
9041536-50	E6,3	E6	50	25	11	-
9041537-50	E6,3	E7	50	25	12	-
9041538-50	E6,3	E8	50	25	12,5	-
9041539-50	E6,3	E10	50	25	15	-
9041540-50	E6,3	E12	50	25	17	-

Nástavec bitů 6-ti hranný s 3 bodovým magnetem L50

Nut setters 6-point with 3-point magnet L50



Kód	Pohon	Výstup	L	L1	D1	D
Code	Input	Output	L	L1	D1	D
9041505-50-2	E6,3	SW5,5	50	25	12,5	-
9041506-50-2	E6,3	SW6	50	25	14	-
9041507-50-2	E6,3	SW7	50	25	14,5	-
9041508-50-2	E6,3	SW8	50	25	15,5	-
9041509-50-2	E6,3	SW9	50	25	16	-
9041510-50-2	E6,3	SW10	50	25	18	-
9041511-50-2	E6,3	SW11	50	25	18	-
9041512-50-2	E6,3	SW12	50	25	20	-
9041513-50-2	E6,3	SW13	50	25	22	-
9041514-50-2	E6,3	SW14	50	25	24	-

Nástavec bitů 6-ti hranný Surface-drive L50

Nut setters surface-drive L50



Kód	Pohon	Výstup	L	L1	D1	D
Code	Input	Output	L	L1	D1	D
9041505-50-4	E6,3	SW5,5	50	25	12,5	-
9041506-50-4	E6,3	SW6	50	25	14	-
9041507-50-4	E6,3	SW7	50	25	14,5	-
9041508-50-4	E6,3	SW8	50	25	15,5	-
9041509-50-4	E6,3	SW9	50	25	16	-
9041510-50-4	E6,3	SW10	50	25	18	-
9041511-50-4	E6,3	SW11	50	25	18	-
9041512-50-4	E6,3	SW12	50	25	20	-
9041513-50-4	E6,3	SW13	50	25	22	-
9041514-50-4	E6,3	SW14	50	25	24	-

Nástavec bitů 6-ti hranný tyčový magnet L50

Nut setters 6-point with central magnet L50



Kód	Pohon	Výstup	L	L1	D1	D
Code	Input	Output	L	L1	D1	D
9041505-50-1	E6,3	SW5,5	50	25	12,5	-
9041506-50-1	E6,3	SW6	50	25	14	-
9041507-50-1	E6,3	SW7	50	25	14,5	-
9041508-50-1	E6,3	SW8	50	25	15,5	-
9041509-50-1	E6,3	SW9	50	25	16	-
9041510-50-1	E6,3	SW10	50	25	18	-
9041511-50-1	E6,3	SW11	50	25	18	-
9041512-50-1	E6,3	SW12	50	25	20	-
9041513-50-1	E6,3	SW13	50	25	22	-
9041514-50-1	E6,3	SW14	50	25	24	-
9041534-50-1	E6,3	E4	50	25	10	-
9041535-50-1	E6,3	E5	50	25	10	-
9041536-50-1	E6,3	E6	50	25	11	-
9041537-50-1	E6,3	E7	50	25	12	-
9041538-50-1	E6,3	E8	50	25	12,5	-
9041539-50-1	E6,3	E10	50	25	15	-
9041540-50-1	E6,3	E12	50	25	17	-

covertec náradí

covertec tools



Nástavec bitů 6-ti hranný L75

Nut setters 6-point L75



Kód	Pohon	Výstup	L	L1	D1	D
Code	Input	Output	L	L1	D1	D
9041505-75	E6,3	SW5,5	75	23	15	12
9041506-75	E6,3	SW6	75	23	16	12
9041507-75	E6,3	SW7	75	28	14,8	12
9041508-75	E6,3	SW8	75	28	16	12
9041509-75	E6,3	SW9	75	28	16	12
9041510-75	E6,3	SW10	75	28	18	12
9041511-75	E6,3	SW11	75	28	18	12
9041512-75	E6,3	SW12	75	28	20	12
9041513-75	E6,3	SW13	75	28	22	12
9041514-75	E6,3	SW14	75	28	23	12
9041534-75	E6,3	E4	75	28	16	12
9041535-75	E6,3	E5	75	28	16	12
9041536-75	E6,3	E6	75	28	16	12
9041537-75	E6,3	E7	75	28	16	12
9041538-75	E6,3	E8	75	28	16	12
9041539-75	E6,3	E10	75	28	16	12
9041540-75	E6,3	E12	75	28	17	12

Nástavec bitů 6-ti hranný tyčový magnet L75

Nut setters 6-point with central magnet L75



Kód	Pohon	Výstup	L	L1	D1	D
Code	Input	Output	L	L1	D1	D
9041505-75-1	E6,3	SW5,5	75	23	15	12
9041506-75-1	E6,3	SW6	75	23	16	12
9041507-75-1	E6,3	SW7	75	28	14,8	12
9041508-75-1	E6,3	SW8	75	28	16	12
9041509-75-1	E6,3	SW9	75	28	16	12
9041510-75-1	E6,3	SW10	75	28	18	12
9041511-75-1	E6,3	SW11	75	28	18	12
9041512-75-1	E6,3	SW12	75	28	20	12
9041513-75-1	E6,3	SW13	75	28	22	12
9041514-75-1	E6,3	SW14	75	28	23	12
9041534-75-1	E6,3	E4	75	28	16	12
9041535-75-1	E6,3	E5	75	28	16	12
9041536-75-1	E6,3	E6	75	28	16	12
9041537-75-1	E6,3	E7	75	28	16	12
9041538-75-1	E6,3	E8	75	28	16	12
9041539-75-1	E6,3	E10	75	28	16	12
9041540-75-1	E6,3	E12	75	28	17	12

Nástavec bitů 6-ti hranný s 3 bodovým magnetem L75

Nut setters 6-point with 3-point magnet L75



Kód	Pohon	Výstup	L	L1	D1	D
Code	Input	Output	L	L1	D1	D
9041505-75-2	E6,3	SW5,5	75	23	15	12
9041506-75-2	E6,3	SW6	75	23	16	12
9041507-75-2	E6,3	SW7	75	28	14,8	12
9041508-75-2	E6,3	SW8	75	28	16	12
9041509-75-2	E6,3	SW9	75	28	16	12
9041510-75-2	E6,3	SW10	75	28	18	12
9041511-75-2	E6,3	SW11	75	28	18	12
9041512-75-2	E6,3	SW12	75	28	20	12
9041513-75-2	E6,3	SW13	75	28	22	12
9041514-75-2	E6,3	SW14	75	28	23	12

Nástavec bitů 6-ti hranný Surface-drive L75

Nut setters surface-drive L75



Kód	Pohon	Výstup	L	L1	D1	D
Code	Input	Output	L	L1	D1	D
9041505-75-4	E6,3	SW5,5	75	23	15	12
9041506-75-4	E6,3	SW6	75	23	16	12
9041507-75-4	E6,3	SW7	75	28	14,8	12
9041508-75-4	E6,3	SW8	75	28	16	12
9041509-75-4	E6,3	SW9	75	28	16	12
9041510-75-4	E6,3	SW10	75	28	18	12
9041511-75-4	E6,3	SW11	75	28	18	12
9041512-75-4	E6,3	SW12	75	28	20	12
9041513-75-4	E6,3	SW13	75	28	22	12
9041514-75-4	E6,3	SW14	75	28	23	12

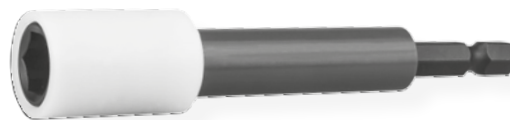

Nástavec bitů 6-ti hranný L100
Nut setters 6-point L100



Kód	Pohon	Výstup	L	L1	D1	D
Code	Input	Output	L	L1	D1	D
9041505-100	E6,3	SW5,5	100	23	15	12
9041506-100	E6,3	SW6	100	23	16	12
9041507-100	E6,3	SW7	100	28	14,8	12
9041508-100	E6,3	SW8	100	28	16	12
9041509-100	E6,3	SW9	100	28	16	12
9041510-100	E6,3	SW10	100	28	18	12
9041511-100	E6,3	SW11	100	28	18	12
9041512-100	E6,3	SW12	100	28	20	12
9041513-100	E6,3	SW13	100	28	22	12
9041514-100	E6,3	SW14	100	28	23	12
9041534-100	E6,3	E4	100	28	16	12
9041535-100	E6,3	E5	100	28	16	12
9041536-100	E6,3	E6	100	28	16	12
9041537-100	E6,3	E7	100	28	16	12
9041538-100	E6,3	E8	100	28	16	12
9041539-100	E6,3	E10	100	28	16	12
9041540-100	E6,3	E12	100	28	17	12

Nástavec bitů 6-ti hranný tyčový magnet L100
Nut setters 6-point with central magnet L100



Kód	Pohon	Výstup	L	L1	D1	D
Code	Input	Output	L	L1	D1	D
9041505-100-1	E6,3	SW5,5	100	23	15	12
9041506-100-1	E6,3	SW6	100	23	16	12
9041507-100-1	E6,3	SW7	100	28	14,8	12
9041508-100-1	E6,3	SW8	100	28	16	12
9041509-100-1	E6,3	SW9	100	28	16	12
9041510-100-1	E6,3	SW10	100	28	18	12
9041511-100-1	E6,3	SW11	100	28	18	12
9041512-100-1	E6,3	SW12	100	28	20	12
9041513-100-1	E6,3	SW13	100	28	22	12
9041514-100-1	E6,3	SW14	100	28	23	12
9041534-100-1	E6,3	E4	100	28	16	12
9041535-100-1	E6,3	E5	100	28	16	12
9041536-100-1	E6,3	E6	100	28	16	12
9041537-100-1	E6,3	E7	100	28	16	12
9041538-100-1	E6,3	E8	100	28	16	12
9041539-100-1	E6,3	E10	100	28	16	12
9041540-100-1	E6,3	E12	100	28	17	12

Nástavec bitů 6-ti hranný s 3 bodovým magnetem L100
Nut setters 6-point with 3-point magnet L100



Kód	Pohon	Výstup	L	L1	D1	D
Code	Input	Output	L	L1	D1	D
9041505-100-2	E6,3	SW5,5	100	23	15	12
9041506-100-2	E6,3	SW6	100	23	16	12
9041507-100-2	E6,3	SW7	100	28	14,8	12
9041508-100-2	E6,3	SW8	100	28	16	12
9041509-100-2	E6,3	SW9	100	28	16	12
9041510-100-2	E6,3	SW10	100	28	18	12
9041511-100-2	E6,3	SW11	100	28	18	12
9041512-100-2	E6,3	SW12	100	28	20	12
9041513-100-2	E6,3	SW13	100	28	22	12
9041514-100-2	E6,3	SW14	100	28	23	12

Nástavec bitů 6-ti hranný Surface-drive L100
Nut setters surface-drive L100



Kód	Pohon	Výstup	L	L1	D1	D
Code	Input	Output	L	L1	D1	D
9041505-100-4	E6,3	SW5,5	100	23	15	12
9041506-100-4	E6,3	SW6	100	23	16	12
9041507-100-4	E6,3	SW7	100	28	14,8	12
9041508-100-4	E6,3	SW8	100	28	16	12
9041509-100-4	E6,3	SW9	100	28	16	12
9041510-100-4	E6,3	SW10	100	28	18	12
9041511-100-4	E6,3	SW11	100	28	18	12
9041512-100-4	E6,3	SW12	100	28	20	12
9041513-100-4	E6,3	SW13	100	28	22	12
9041514-100-4	E6,3	SW14	100	28	23	12

covertec náradí

covertec tools



Nástavec bitů 6-ti hranný L150

Nut setters 6-point L150



Kód	Pohon	Výstup	L	L1	D1	D
Code	Input	Output	L	L1	D1	D
9041505-150	E6,3	SW5,5	150	23	15	12
9041506-150	E6,3	SW6	150	23	16	12
9041507-150	E6,3	SW7	150	28	14,8	12
9041508-150	E6,3	SW8	150	28	16	12
9041509-150	E6,3	SW9	150	28	16	12
9041510-150	E6,3	SW10	150	28	18	12
9041511-150	E6,3	SW11	150	28	18	12
9041512-150	E6,3	SW12	150	28	20	12
9041513-150	E6,3	SW13	150	28	22	12
9041514-150	E6,3	SW14	150	28	23	12
9041534-150	E6,3	E4	150	28	16	12
9041535-150	E6,3	E5	150	28	16	12
9041536-150	E6,3	E6	150	28	16	12
9041537-150	E6,3	E7	150	28	16	12
9041538-150	E6,3	E8	150	28	16	12
9041539-150	E6,3	E10	150	28	16	12
9041540-150	E6,3	E12	150	28	17	12

Nástavec bitů 6-ti hranný s 3 bodovým magnetem L150

Nut setters 3-point magnet L150



Kód	Pohon	Výstup	L	L1	D1	D
Code	Input	Output	L	L1	D1	D
9041505-150-2	E6,3	SW5,5	150	23	15	12
9041506-150-2	E6,3	SW6	150	23	16	12
9041507-150-2	E6,3	SW7	150	28	14,8	12
9041508-150-2	E6,3	SW8	150	28	16	12
9041509-150-2	E6,3	SW9	150	28	16	12
9041510-150-2	E6,3	SW10	150	28	18	12
9041511-150-2	E6,3	SW11	150	28	18	12
9041512-150-2	E6,3	SW12	150	28	20	12
9041513-150-2	E6,3	SW13	150	28	22	12
9041514-150-2	E6,3	SW14	150	28	23	12

Nástavec bitů 6-ti hranný Surface-drive L150

Nut setters 6-point surface-drive L150



Kód	Pohon	Výstup	L	L1	D1	D
Code	Input	Output	L	L1	D1	D
9041505-150-4	E6,3	SW5,5	150	23	15	12
9041506-150-4	E6,3	SW6	150	23	16	12
9041507-150-4	E6,3	SW7	150	28	14,8	12
9041508-150-4	E6,3	SW8	150	28	16	12
9041509-150-4	E6,3	SW9	150	28	16	12
9041510-150-4	E6,3	SW10	150	28	18	12
9041511-150-4	E6,3	SW11	150	28	18	12
9041512-150-4	E6,3	SW12	150	28	20	12
9041513-150-4	E6,3	SW13	150	28	22	12
9041514-150-4	E6,3	SW14	150	28	23	12

Nástavec bitů 6-ti hranný tyčový magnet L150

Nut setters 6-point with central magnet L150



Kód	Pohon	Výstup	L	L1	D1	D
Code	Input	Output	L	L1	D1	D
9041505-150-1	E6,3	SW5,5	150	23	15	12
9041506-150-1	E6,3	SW6	150	23	16	12
9041507-150-1	E6,3	SW7	150	28	14,8	12
9041508-150-1	E6,3	SW8	150	28	16	12
9041509-150-1	E6,3	SW9	150	28	16	12
9041510-150-1	E6,3	SW10	150	28	18	12
9041511-150-1	E6,3	SW11	150	28	18	12
9041512-150-1	E6,3	SW12	150	28	20	12
9041513-150-1	E6,3	SW13	150	28	22	12
9041514-150-1	E6,3	SW14	150	28	23	12
9041534-150-1	E6,3	E4	150	28	16	12
9041535-150-1	E6,3	E5	150	28	16	12
9041536-150-1	E6,3	E6	150	28	16	12
9041537-150-1	E6,3	E7	150	28	16	12
9041538-150-1	E6,3	E8	150	28	16	12
9041539-150-1	E6,3	E10	150	28	16	12
9041540-150-1	E6,3	E12	150	28	17	12

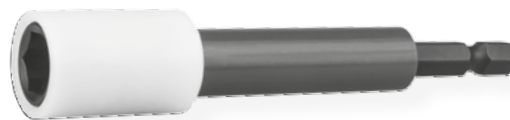

Nástavec bitů 6-ti hranný L200
Nut setters 6-point L200



Kód	Pohon	Výstup	L	L1	D1	D
Code	Input	Output	L	L1	D1	D
9041505-200	E6,3	SW5,5	200	23	15	12
9041506-200	E6,3	SW6	200	23	16	12
9041507-200	E6,3	SW7	200	28	14,8	12
9041508-200	E6,3	SW8	200	28	16	12
9041509-200	E6,3	SW9	200	28	16	12
9041510-200	E6,3	SW10	200	28	18	12
9041511-200	E6,3	SW11	200	28	18	12
9041512-200	E6,3	SW12	200	28	20	12
9041513-200	E6,3	SW13	200	28	22	12
9041514-200	E6,3	SW14	200	28	23	12
9041534-200	E6,3	E4	200	28	16	12
9041535-200	E6,3	E5	200	28	16	12
9041536-200	E6,3	E6	200	28	16	12
9041537-200	E6,3	E7	200	28	16	12
9041538-200	E6,3	E8	200	28	16	12
9041539-200	E6,3	E10	200	28	16	12
9041540-200	E6,3	E12	200	28	17	12

Nástavec bitů 6-ti hranný s 3 bodovým magnetem L200
Nut setters 6-point with 3-point magnet L200



Kód	Pohon	Výstup	L	L1	D1	D
Code	Input	Output	L	L1	D1	D
9041505-200-2	E6,3	SW5,5	200	23	15	12
9041506-200-2	E6,3	SW6	200	23	16	12
9041507-200-2	E6,3	SW7	200	28	14,8	12
9041508-200-2	E6,3	SW8	200	28	16	12
9041509-200-2	E6,3	SW9	200	28	16	12
9041510-200-2	E6,3	SW10	200	28	18	12
9041511-200-2	E6,3	SW11	200	28	18	12
9041512-200-2	E6,3	SW12	200	28	20	12
9041513-200-2	E6,3	SW13	200	28	22	12
9041514-200-2	E6,3	SW14	200	28	23	12

Nástavec bitů 6-ti hranný Surface-drive L200
Nut setters surface-drive L200



Kód	Pohon	Výstup	L	L1	D1	D
Code	Input	Output	L	L1	D1	D
9041505-200-4	E6,3	SW5,5	200	23	15	12
9041506-200-4	E6,3	SW6	200	23	16	12
9041507-200-4	E6,3	SW7	200	28	14,8	12
9041508-200-4	E6,3	SW8	200	28	16	12
9041509-200-4	E6,3	SW9	200	28	16	12
9041510-200-4	E6,3	SW10	200	28	18	12
9041511-200-4	E6,3	SW11	200	28	18	12
9041512-200-4	E6,3	SW12	200	28	20	12
9041513-200-4	E6,3	SW13	200	28	22	12
9041514-200-4	E6,3	SW14	200	28	23	12

Nástavec bitů 6-ti hranný tyčový magnet L200
Nut setters 6-point with central magnet L200



Kód	Pohon	Výstup	L	L1	D1	D
Code	Input	Output	L	L1	D1	D
9041505-200-1	E6,3	SW5,5	200	23	15	12
9041506-200-1	E6,3	SW6	200	23	16	12
9041507-200-1	E6,3	SW7	200	28	14,8	12
9041508-200-1	E6,3	SW8	200	28	16	12
9041509-200-1	E6,3	SW9	200	28	16	12
9041510-200-1	E6,3	SW10	200	28	18	12
9041511-200-1	E6,3	SW11	200	28	18	12
9041512-200-1	E6,3	SW12	200	28	20	12
9041513-200-1	E6,3	SW13	200	28	22	12
9041514-200-1	E6,3	SW14	200	28	23	12
9041534-200-1	E6,3	E4	200	28	16	12
9041535-200-1	E6,3	E5	200	28	16	12
9041536-200-1	E6,3	E6	200	28	16	12
9041537-200-1	E6,3	E7	200	28	16	12
9041538-200-1	E6,3	E8	200	28	16	12
9041539-200-1	E6,3	E10	200	28	16	12
9041540-200-1	E6,3	E12	200	28	17	12



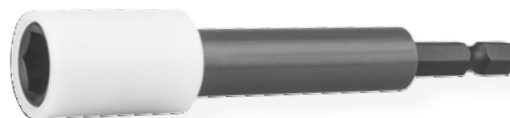

Nástavec bitů 6-ti hranný L250

Nut setters 6-point L250



Kód	Pohon	Výstup	L	L1	D1	D
Code	Input	Output	L	L1	D1	D
9041505-250	E6,3	SW5,5	250	23	15	12
9041506-250	E6,3	SW6	250	23	16	12
9041507-250	E6,3	SW7	250	28	14,8	12
9041508-250	E6,3	SW8	250	28	16	12
9041509-250	E6,3	SW9	250	28	16	12
9041510-250	E6,3	SW10	250	28	18	12
9041511-250	E6,3	SW11	250	28	18	12
9041512-250	E6,3	SW12	250	28	20	12
9041513-250	E6,3	SW13	250	28	22	12
9041514-250	E6,3	SW14	250	28	23	12
9041534-250	E6,3	E4	250	28	16	12
9041535-250	E6,3	E5	250	28	16	12
9041536-250	E6,3	E6	250	28	16	12
9041537-250	E6,3	E7	250	28	16	12
9041538-250	E6,3	E8	250	28	16	12
9041539-250	E6,3	E10	250	28	16	12
9041540-250	E6,3	E12	250	28	17	12

Nástavec bitů 6-ti hranný tyčový magnet L250

Nut setters 6-point with central magnet L250



Kód	Pohon	Výstup	L	L1	D1	D
Code	Input	Output	L	L1	D1	D
9041505-250-1	E6,3	SW5,5	250	23	15	12
9041506-250-1	E6,3	SW6	250	23	16	12
9041507-250-1	E6,3	SW7	250	28	14,8	12
9041508-250-1	E6,3	SW8	250	28	16	12
9041509-250-1	E6,3	SW9	250	28	16	12
9041510-250-1	E6,3	SW10	250	28	18	12
9041511-250-1	E6,3	SW11	250	28	18	12
9041512-250-1	E6,3	SW12	250	28	20	12
9041513-250-1	E6,3	SW13	250	28	22	12
9041514-250-1	E6,3	SW14	250	28	23	12
9041534-250-1	E6,3	E4	250	28	16	12
9041535-250-1	E6,3	E5	250	28	16	12
9041536-250-1	E6,3	E6	250	28	16	12
9041537-250-1	E6,3	E7	250	28	16	12
9041538-250-1	E6,3	E8	250	28	16	12
9041539-250-1	E6,3	E10	250	28	16	12
9041540-250-1	E6,3	E12	250	28	17	12

Nástavec bitů 6-ti hranný Surface-drive L250

Nut setters surface-drive L250



Kód	Pohon	Výstup	L	L1	D1	D
Code	Input	Output	L	L1	D1	D
9041505-250-4	E6,3	SW5,5	250	23	15	12
9041506-250-4	E6,3	SW6	250	23	16	12
9041507-250-4	E6,3	SW7	250	28	14,8	12
9041508-250-4	E6,3	SW8	250	28	16	12
9041509-250-4	E6,3	SW9	250	28	16	12
9041510-250-4	E6,3	SW10	250	28	18	12
9041511-250-4	E6,3	SW11	250	28	18	12
9041512-250-4	E6,3	SW12	250	28	20	12
9041513-250-4	E6,3	SW13	250	28	22	12
9041514-250-4	E6,3	SW14	250	28	23	12

Nástavec bitů 6-ti hranný s 3 bodovým magnetem L250

Nut setters 6-point with 3-point magnet L250



Kód	Pohon	Výstup	L	L1	D1	D
Code	Input	Output	L	L1	D1	D
9041505-250-2	E6,3	SW5,5	250	23	15	12
9041506-250-2	E6,3	SW6	250	23	16	12
9041507-250-2	E6,3	SW7	250	28	14,8	12
9041508-250-2	E6,3	SW8	250	28	16	12
9041509-250-2	E6,3	SW9	250	28	16	12
9041510-250-2	E6,3	SW10	250	28	18	12
9041511-250-2	E6,3	SW11	250	28	18	12
9041512-250-2	E6,3	SW12	250	28	20	12
9041513-250-2	E6,3	SW13	250	28	22	12
9041514-250-2	E6,3	SW14	250	28	23	12

covertec E6,3

covertec nářadí

covertec tools

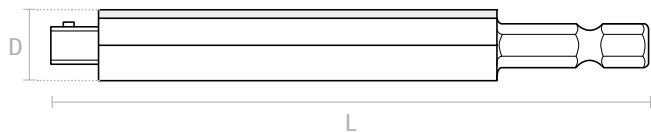

Prodloužení E6,3

Extension E6,3



Kód	Pohon	Výstup	L	L1	D1	D	Náhr. pouzdra
Code	Input	Output	L	L1	D1	D	Repl. Sleeves
9060010	E6,3	1/4"	50	-	-	12	9061010
9060011	E6,3	1/4"	100	-	-	12	9061011
9060012	E6,3	1/4"	150	-	-	12	9061012
9060015	E6,3	1/4"	200	-	-	12	9061015
9060016	E6,3	1/4"	250	-	-	12	9061016
3230051	E6,3	1/4"	380	-	-	12	3230051
3030336	E6,3	1/4"	400	-	-	12	3030336
9060013	E6,3	3/8"	50	-	-	12	9061013
9060014	E6,3	3/8"	100	-	-	12	9061014
2110593	E6,3	3/8"	125	-	-	12	2110593
3930327	E6,3	3/8"	150	-	-	12	3930327
2110629	E6,3	3/8"	175	-	-	12	2110629
2110579	E6,3	3/8"	225	-	-	12	2110579
9060017	E6,3	3/8"	250	-	-	12	9061017
9060024	E6,3	3/8"	300	-	-	12	9061024
9060047	E6,3	3/8"	350	-	-	12	9061047
9060048	E6,3	3/8"	400	-	-	12	9061048
9060049	E6,3	3/8"	450	-	-	12	9061049

E11

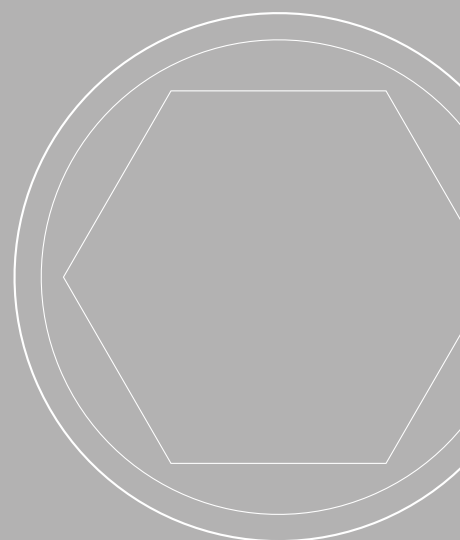
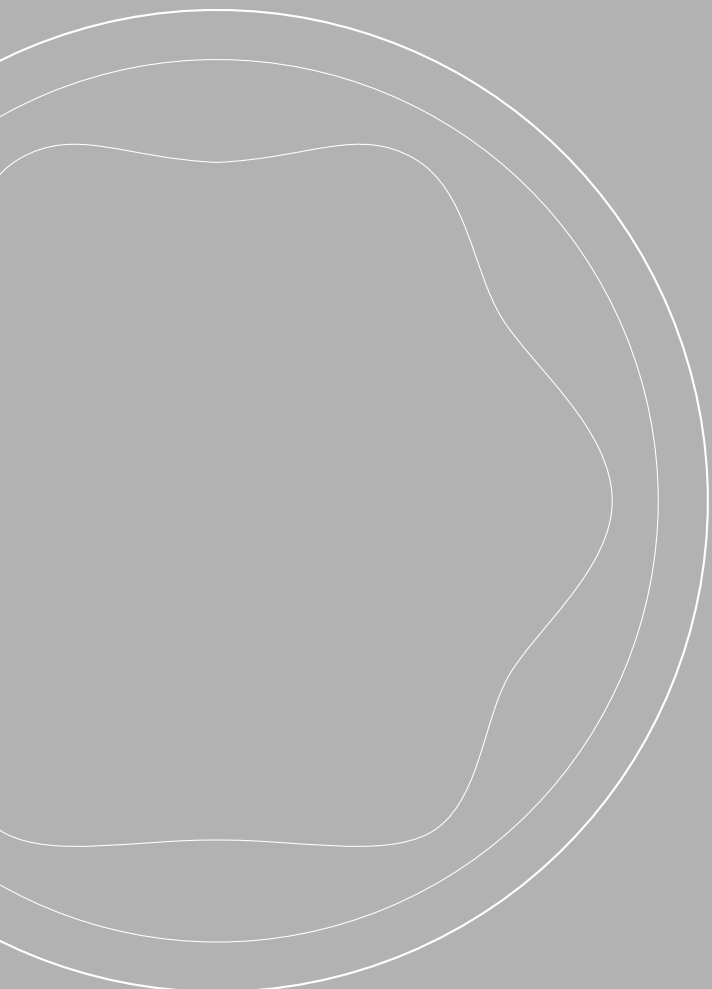

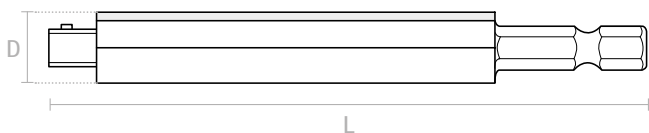

Prodloužení E11

Extension E11

Kód	Pohon	Výstup	L	L1	D1	D	Náhr. pouzdra
Code	Input	Output	L	L1	D1	D	Repl. Sleeves
9060201	E11	3/8"	70	-	-	18	9061201
9060202	E11	3/8"	125	-	-	18	9061202
9060203	E11	3/8"	200	-	-	18	9061203
2730108	E11	3/8"	280	-	-	18	2730108
			-	-	-	-	
9060251	E11	1/2"	70	-	-	25	9061251
9060252	E11	1/2"	125	-	-	25	9061252
9060253	E11	1/2"	200	-	-	25	9061253

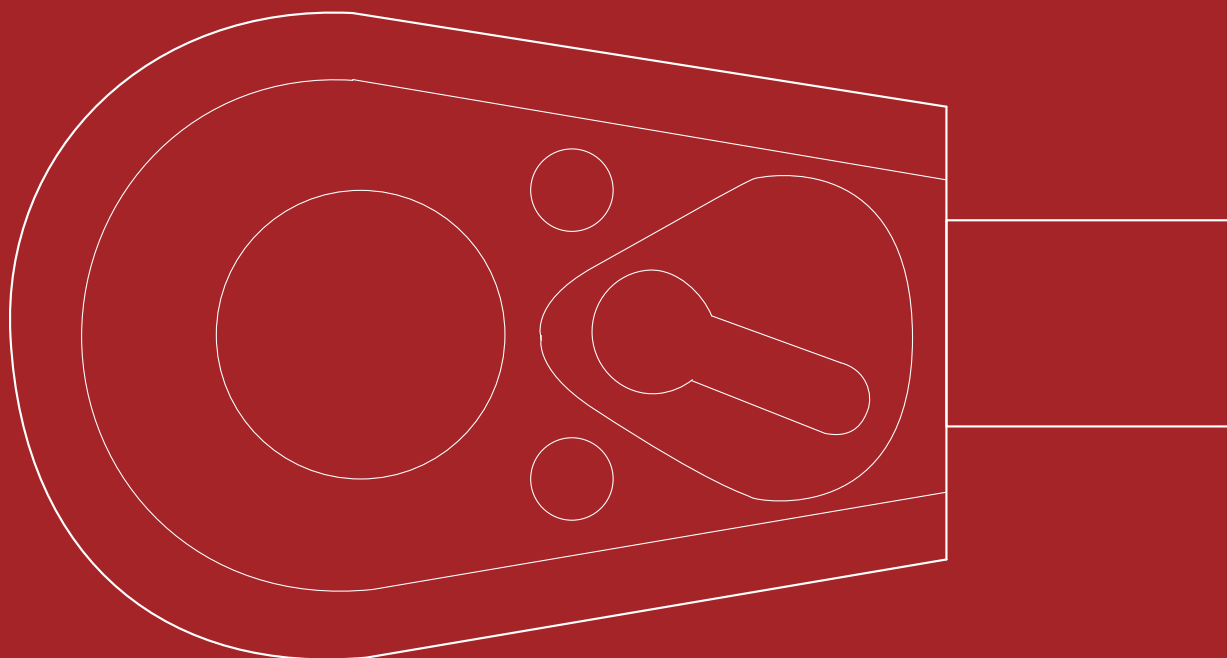

covertec – ochrana se systémem

covertec – Systematic protection

Zacvakávací kryty pro ráčny covertec

covertec click-fit shields



Málokterý montážní nástroj je tak rozšířený jako zásuvné a přepínací ráčny. Staly se nepostradatelnou součástí mnoha montážních procesů. Stejně běžné jako jejich použití jsou však výsledná poškození laku a povrchu. Zatímco rukojeť je obvykle chráněna gumovým povlakem, holá hlava může při kontaktu s lakem nebo povrchy způsobit poškození. Se zacvakávacími kryty covertec nyní můžete účinně chránit i hlavu ráčny. Zacvakněte a začněte.

Ratchet adapters and reversible ratchets are incredibly common assembly tools. They are an essential component of so many assembly processes. Unfortunately, the resulting damage to paint and surface finishes is equally ubiquitous. Although the handle is generally protected with a rubber sleeve, the bare head can cause damage when it comes into contact with the paint or other surface finish. With covertec click-fit shields, you can now effectively protect the ratchet head as well. Simply push on the sleeve and get started.

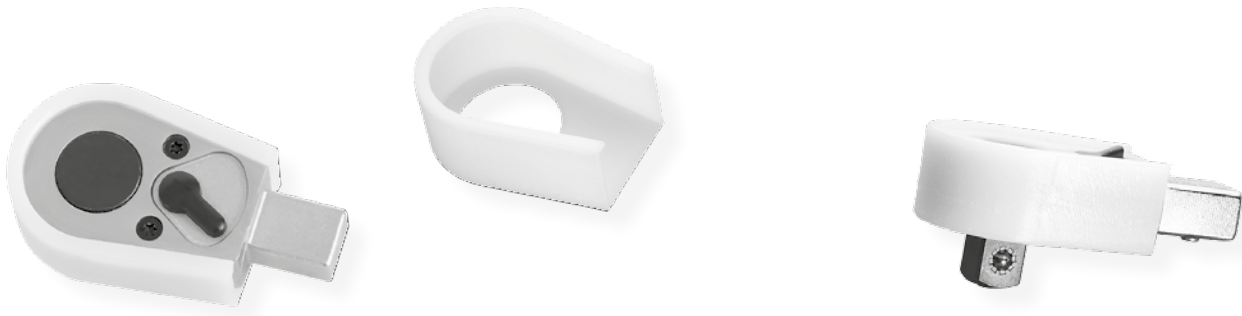

Výrobce ráčen Hazet

Ratchet manufacturer Hazet

Artikl.-č.	Výstup	Výrobní č.	Držák
Part number	Output	Manufacturer Nr.	Holding fixture
9071001	1/4"	6401-1	9 x 12
9071002	3/8"	6402-1	9 x 12
9071003	1/2"	6403-1	9 x 12
9071004	1/2"	6404-1	14 x 18
9071005	1/4"	6401N	9 x 12
9071006	3/8"	6402	9 x 12
9071007	1/2"	6403	9 x 12
9071008	1/2"	6404	14 x 18
9071001	1/4"	6401-1S	9 x 12
9071002	3/8"	6402-1S	9 x 12
9071003	1/2"	6403-1S	9 x 12
9071004	1/2"	6404-1S	14 x 18
9071009	C6,3	6408	9 x 12
9071002	C8	6408-1	9 x 12

Výrobce ráčen Hazet

Ratchet manufacturer Hazet

Artikl.-č.	Výstup	Výrobní č.
Part number	Output	Manufacturer Nr.
9080001	1/4"	863
9080002	3/8"	8816
9080003	1/2"	916SP

Výrobce ráčen Garant

Ratchet manufacturer Garant

Artikl.-č.	Výstup	Výrobní č.	Držák
Part number	Output	Manufacturer Nr.	Holding fixture
9080007	1/4"	632030	9 x 12
9080008	3/8"	635030	9 x 12
9080009	1/2"	640030	9 x 12

Zacvakávací kryty pro ráčny covertec

covertec Click-fit shields



Výrobce ráčen Stahlwille

Ratchet manufacturer Stahlwille

Artikl.-č.	Výstup	Výrobní č.	Velikost	Držák
Part number	Output	Manufacturer Nr.	Size	Holding fixture
725QR				
9071011	1/4"	58 25 30 04	9 x 12	4
9071012	3/8"	58 25 30 05	9 x 12	5
9071013	1/2"	58 25 30 10	9 x 12	10
9071014	1/2"	58 25 30 20	14 x 18	20
725/B				
9071015	C6,3	58 25 50 04	9 x 12	4
9071016	C8	58 25 50 05	9 x 12	5
725/4				
9071017	1/4"	58 25 40 04	9 x 12	
735				
9071018	3/8"	58 25 00 05	9 x 12	5
9071019	1/2"	58 25 00 10	9 x 12	10
9071020	1/2"	58 25 00 20	14 x 18	20
9071021	3/4"	58 25 00 40	14 x 18	40

Výrobce ráčen Saltus

Ratchet manufacturer Saltus

Artikl.-č.	Výstup	Výrobní č.	Držák
Part number	Output	Manufacturer Nr.	Holding fixture
9071022	1/4"	29/DC-1/4	9 x 12
9071023	3/8"	29/DC-3/8	9 x 12
725/B			
9071024	1/4"	30/DC-1/4	9 x 12
9071025	3/8"	30/DC-3/8	9 x 12
9071029	1/2"	30/DC-1/2	9 x 12
725/4			
9071026	1/4"	31/DC-1/4	9 x 12
9071027	3/8"	31/DC-3/8	9 x 12
9071028	1/2"	31/DC-1/2	9 x 12

Výrobce ráčen Stahlwille

Ratchet manufacturer Stahlwille

Artikl.-č.	Výstup	Výrobní č.
Part number	Output	Manufacturer Nr.
9080004	1/4"	415 / 415QR 11 11 00 10
9080005	3/8"	435 / 435QR 12 11 00 10
9080006	1/2"	512 / 512QR 13 11 00 10

... a co s tím ještě souvisí.

... and what goes with it.

covertec příslušenství

covertec Accessories



covertec příslušenství

Se speciálním kladivem ekatec z měkké pryže lze výborně montovat citlivé komponenty. Obkladové díly, lišty nebo skla jsou osazeny pomocí našeho speciálního kladiva, aniž by došlo k jejich poškození. Navíc se výrazně zlepšila zdravotní zátěž, která může být způsobena vašim zaměstnancům.

Covertec softblow hammer

This special soft rubber hammer from ekatec is ideal for fitting sensitive components. Sections of panelling, trims or glass can be fitted without damage by using our special hammer. It also improves the health hazards of your employees.



covertec povlakování

Není neobvyklé, že během procesu montáže dojde k poškození viditelných částí povrchů nástroji. Abychom tomu zabránili, nabízíme účinné ochranné povlakování.

Covertec coating

It is not unusual for the surface finish of visible parts, that they are damaged by tools during the assembly process. We are offering effective, protective coatings to avoid these damages.



covertec navíjecí roller na známku

Součástí systému ochrany laku covertec.

Covertec roller stamp

A module of the covertec paint protection system.



HHD0028



Ochranný obal Protective Sleeve



Textilní potah Fabric cover



HHD0029



HHD0030



HHD0031

Boxy na nářadí a rozdělovací vložky covertec

S boxy na nářadí z řady covertec získáte účinný systém pro vaše nářadí a montážní materiál, který zajišťuje nejen pořádek, ale i ochrannou funkci proti poškození laku a povrchu při montáži. Škrábance od náhodného odření karoserie auta boxem na nářadí jsou minulostí. Také při umístění boxu na nářadí např. na karoserii, je tato spolehlivě chráněna proti poškrábání ochranným potahem boxu.

K dispozici jsou 3 velikosti boxů s různými vložkami a příslušným ochranným krytem a textilním potahem pro vaše nářadí.

Covertec carrying case and inserts

The toolboxes of the covertec series provide a system for keeping your tools and assembly equipment, which does not only keep them in order. They also offer additional protection against damages to paint and surface during the assembly process. Scratches caused by accidentally scraping of the toolbox against the bodywork are now a thing of the past.

There are 3 different carrying cases with different inserts and protective sleeves available, as well as a fabric cover for your tools. Also in cases of putting the toolbox down on parts of the bodywork, the provides a reliable protection against scratches.

Přenosný box	Toolbox	Číslo
425-240, 4-dílný	Insert 4-fold	HHD0028
425-365, 6-dílný	Insert 6-fold	HHD0033
237-215, 2-dílný	Insert 2-fold	HHD0032

Ochranný obal	Protective Sleeve	Číslo
425-240, 3-dílný	Insert 3-fold	2110017
425-365, 6-dílný	Insert 6-fold	2110018
437-215, 2-dílný	Insert 2-fold	2110029

Textilní potah	Fabric cover	Číslo
425-240, 3-dílný	Insert 3-fold	2110017-S
425-365, 6-dílný	Insert 6-fold	2110018-S
437-215, 2-dílný	Insert 2-fold	2110029-S

Vložky	Insert	Číslo
Vložky 3-dílné	Insert 3-fold	HHD0029
Vložky 6-dílné	Insert 6-fold	HHD0035
Vložky 2-dílné	Insert 2-fold	HHD0030
Vložky 1-dílné	Insert 1-fold	HHD0031



covertec taška na nářadí

Pouzdro na nářadí na opasek bylo speciálně navrženo pro požadavky automobilového průmyslu. Pouzdro nabízí prostor pro mnoho nástrojů je určeno i pro větší nástroje. Mobilita není omezena. Ztráta nástrojů je minimalizována pevným zámkem - je zabráněno poškození laku volně nošenými nástroji. Brašna na nářadí je vyrobena z vysoce kvalitní kůže. Vzhledem k dostupnosti skladem jsou dodací lhůty velmi krátké.



Covertec tool bag

The belt tool bag was specially designed for the requirements of the automotive industry. The tool bag offers enough space for a lot of tools and covers even large tools. The movement is not restricted. The robust closure minimises tool losses and prevents damages of unprotected paintwork from tools. It is made of high-quality leather. The tool bag is available from stock, so delivery times are very short.



covertec zvláštní kleště

Kleště se speciální povrchovou úpravou covertec.

Covertec-Special pliers

Pliers with special Covertec-coating.

Rozměry v tomto katalogu nejsou závazné.
Technické změny vyhrazeny. Na vyžádání rádi
poskytneme 3D data.

Pro speciální provedení a technické dotazy nás
neváhejte kontaktovat.

The measures in this catalog are not binding.
Reserve technical changes.
Upon request we can also provide 3D data
to disposal.

For special design and other topics, please
contact us.

Kontaktní adresa ekatec GmbH Römerstraße 30
Contact D-72108 Rottenburg am Neckar
Telefon +49 (0) 7472 93790-0
Telefax +49 (0) 7472 93790-29
info@ekatec-gmbh.de
www.ekatec-gmbh.de

Objednávky
order@ekatec-gmbh.de

Poptávky
tools@ekatec-gmbh.de

Další katalogy
Further Catalogs

We would be pleased to send you further catalogs
or documents.

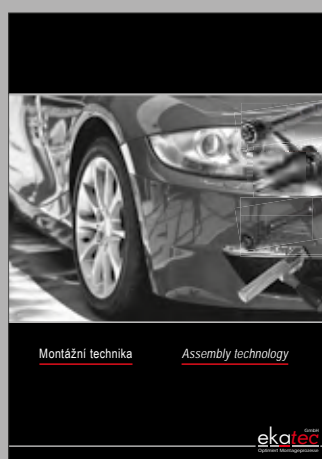
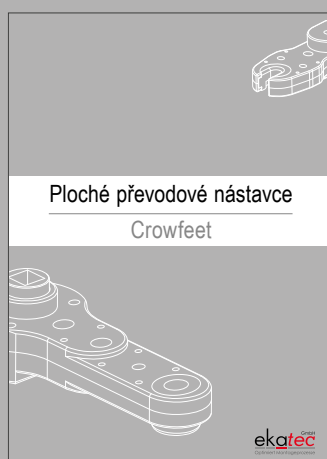



ekatec GmbH
Römerstraße 30
D-72108 Rottenburg-Weiler
Telefon +49 (0) 7472 93790-0
Telefax +49 (0) 7472 93790-29
info@ekatec-gmbh.de
www.ekatec-gmbh.de
www.covertec-werkzeuge.de

The contact information is listed in a clean, black, sans-serif font on the right side of the white central band.